

# Type 8098 FLOWave S

Flowmeter



## Operating Instructions

We reserve the right to make technical changes without notice.  
Technische Änderungen vorbehalten.  
Sous réserve de modifications techniques.

© Bürkert Werke GmbH & Co. KG, 2019 - 2021

Operating Instructions 2105/03\_EU-ML 00815332 / Original DE

# Type 8098 FLOWave S

<b>1</b>	<b>ABOUT THESE OPERATING INSTRUCTIONS .....</b>	<b>15</b>
1.1	Symbols used .....	15
1.2	Definition .....	15
<b>2</b>	<b>INTENDED USE .....</b>	<b>16</b>
2.1	Device with ATEX approval.....	16
<b>3</b>	<b>BASIC SAFETY INFORMATION .....</b>	<b>17</b>
<b>4</b>	<b>GENERAL INFORMATION.....</b>	<b>19</b>
4.1	Manufacturer's address and international contacts .....	19
4.2	Warranty conditions.....	19
4.3	Information on the Internet.....	19
<b>5</b>	<b>DESCRIPTION .....</b>	<b>20</b>
5.1	Structure.....	20
5.1.1	Transmitter variants .....	20
5.1.2	Unlocking magnetic key .....	20
5.2	Type label, adhesive label.....	21
5.3	Type label lasered .....	22
5.4	Certification markings.....	23
5.5	Marking of the Unique Serial Number (USN) .....	23
5.6	Description of the status indicator .....	23
<b>6</b>	<b>TECHNICAL DATA .....</b>	<b>24</b>
6.1	Operating conditions .....	24
6.2	Conformity.....	24
6.3	Standards and directives.....	24
6.3.1	Conformity to the Pressure Equipment Directive .....	25
6.3.2	UL certification .....	25
6.3.3	EHEDG certification.....	26
6.4	Fluid data.....	27
6.5	Measurement data.....	29

6.6	Electrical data .....	30
6.7	Mechanical data.....	31
<b>7</b>	<b>INSTALLATION IN THE PIPE.....</b>	<b>32</b>
7.1	Safety instructions .....	32
7.2	Preparing the device before installation into the pipeline.....	33
7.2.1	Changing the position of the transmitter on the sensor .....	34
7.3	Recommendations for the installation into the pipeline .....	35
7.4	Installing the device into the pipe .....	37
7.4.1	Before installing the device into the pipe.....	37
7.4.2	Installing a device with clamp connections .....	38
7.4.3	Installing a device with flange connections .....	38
7.4.4	Installing a device with threaded connections according to DIN 11851 series A. ....	39
<b>8</b>	<b>ELECTRICAL INSTALLATION.....</b>	<b>40</b>
8.1	Safety instructions .....	40
8.2	Additional documentation .....	41
8.3	Connecting the device to a power supply .....	42
8.4	Connecting the device to a bÜS / CANopen network without outputs .....	43
8.5	Connecting the device to a bÜS / CANopen network with outputs.....	44
8.6	Connecting the protective earth.....	45
<b>9</b>	<b>HOW TO DO THE SETTINGS .....</b>	<b>46</b>
9.1	Safety instructions .....	46
9.2	Preparing the Bürkert Communicator software.....	46
9.2.1	Connecting bÜS device with Bürkert Communicator .....	46
9.3	Available login user levels .....	47
9.4	Default settings .....	47
<b>10</b>	<b>COMMISSIONING .....</b>	<b>48</b>
10.1	Prerequisites .....	48
10.2	Commissioning for measuring the flow rate or for filling containers.....	48
10.3	Commissioning for detecting a change of fluid in the pipe .....	49
10.4	Commissioning for detecting bubbles in the pipe .....	50

<b>11</b>	<b>GENERAL SETTINGS - PARAMETER.....</b>	<b>51</b>
	11.1 Safety instructions .....	51
	11.2 User levels of the editable menu items.....	51
	11.3 Default settings .....	51
	11.4 Changing the operating mode of the status indicator or switching off the status indicator..	52
	11.4.1 Changing the operating mode of the status indicator .....	52
	11.4.2 Switching off the status indicator .....	52
	11.5 Setting the basic parameters for identifying the device on bÜS.....	53
	11.5.1 Entering a name for the device.....	53
	11.5.2 Entering the location of the device .....	53
	11.5.3 Entering a description for the device.....	54
	11.6 Setting the advanced parameters for identifying the device connected to bÜS or to a CANopen fieldbus .....	54
	11.6.1 Entering a unique name for the device .....	54
	11.6.2 Changing the transmission speed on the device .....	55
	11.6.3 Activating the device internal termination resistor.....	55
	11.6.4 Deactivating the device internal termination resistor.....	56
	11.6.5 Changing the address of the device connected to a CANopen fieldbus .....	56
	11.6.6 Setting the digital communication for bÜS or for a CANopen fieldbus .....	57
	11.6.7 Stop sending the measured process data (PDOs) to bÜS or to the CANopen fieldbus .....	58
	11.7 Monitoring the device supply voltage or the device temperature .....	58
	11.7.1 Reading out the 2 error limit values.....	60
	11.7.2 Changing the 2 warning limit values.....	60
	11.7.3 Reading out the hysteresis value.....	60
	11.8 Reading out the low warning limit for the voltage of the internal battery .....	61
	11.9 Activating the diagnostics functions.....	61
	11.10 Disabling all the diagnostics .....	62
	11.11 Set display (NaN or numerical value) if the process value cannot be measured .....	62
<b>12</b>	<b>GENERAL SETTINGS - DIAGNOSTICS .....</b>	<b>63</b>
	12.1 User levels of the menu items .....	63
	12.2 Reading out data related to the device.....	63
	12.2.1 Reading out the number of operating hours of the device.....	63
	12.2.2 Reading out the current value of the internal temperature of the device .....	63

12.2.3	Reading out the minimum or the maximum value of the internal temperature of the device .....	64
12.2.4	Reading out the current value of the supply voltage.....	64
12.2.5	Reading out the minimum or the maximum value of the supply voltage .....	64
12.2.6	Reading out the current value of the current consumption of the device .....	65
12.2.7	Reading out the minimum or the maximum value of the current consumption of the device .....	65
12.2.8	Reading out the number of device starts .....	65
12.2.9	Checking whether the date and time are correct .....	66
12.2.10	Checking the voltage of the internal battery.....	66
<b>12.3</b>	<b>Reading out data related to bÜS .....</b>	<b>67</b>
12.3.1	Reading out the number of current receive errors.....	67
12.3.2	Reading out the maximum number of receive errors since the last power-up of the device .....	67
12.3.3	Reading out the number of current transmit errors .....	67
12.3.4	Reading out the maximum number of transmit errors since the last power-up of the device.....	68
12.3.5	Resetting the 2 maximum error counters .....	68
12.3.6	Reading out whether the measured process data (PDO, process data object) is sent on bÜS or on the CANopen fieldbus .....	68
<b>13</b>	<b>GENERAL SETTINGS - MAINTENANCE.....</b>	<b>69</b>
<b>13.1</b>	<b>User levels of the menu items .....</b>	<b>69</b>
<b>13.2</b>	<b>Reading out some device information .....</b>	<b>69</b>
13.2.1	Reading out the displayed name of the device .....	69
13.2.2	Reading out the article number of the device .....	69
13.2.3	Reading out the serial number of the device.....	69
13.2.4	Reading out the article number of the device software.....	70
13.2.5	Reading out the version number of the device software.....	70
13.2.6	Reading out the version number of the bÜS software.....	70
13.2.7	Reading out the version number of the device hardware.....	70
13.2.8	Reading out the Type number of the device.....	71
13.2.9	Reading out the manufacturing date of the device .....	71
13.2.10	Reading out the version of the embedded eds file.....	71
<b>13.3</b>	<b>Restarting or resetting the device.....</b>	<b>72</b>
13.3.1	Restarting the device.....	72
13.3.2	Resetting the device to all its factory settings.....	72

<b>14</b>	<b>SAW SENSOR - PARAMETER .....</b>	<b>73</b>
14.1	Safety instructions .....	73
14.2	User levels of the editable menu items.....	73
14.3	Default settings .....	73
14.4	Setting the parameters of the volume flow rate .....	74
14.4.1	Giving a user defined name to the measured volume flow rate .....	74
14.4.2	Activating the damping of the volume flow rate values and selecting a pre-defined damping level .....	74
14.4.3	Activating a user-defined damping of the volume flow rate values.....	76
14.4.4	Deactivating the damping of the volume flow rate values.....	77
14.4.5	Activating the monitoring of the volume flow rate .....	77
14.4.6	Deactivating the monitoring of the volume flow rate .....	79
14.4.7	Changing the error limits, the warning limits and the hysteresis of the volume flow rate.....	80
14.4.8	Resetting the default values of the error limits, the warning limits and the hysteresis of the volume flow rate .....	81
14.4.9	Enabling the cut-off function .....	82
14.4.10	Changing the cut-off value of the flow rate .....	83
14.4.11	Disabling the cut-off function .....	83
14.4.12	Resetting the default values of all the volume flow rate parameters .....	84
<b>14.5</b>	<b>Setting the parameters of the liquid temperature.....</b>	<b>85</b>
14.5.1	Giving a user defined name to the measured liquid temperature.....	85
14.5.2	Activating the damping of the liquid temperature values and selecting a predefined damping level .....	85
14.5.3	Activating a user-defined damping of the liquid temperature values .....	87
14.5.4	Deactivating the damping of the liquid temperature values .....	88
14.5.5	Activating the monitoring of the liquid temperature .....	89
14.5.6	Deactivating the monitoring of the liquid temperature .....	90
14.5.7	Changing the error limits, the warning limits and the hysteresis of the liquid temperature .....	90
14.5.8	Resetting the default values of the error limits, the warning limits and the hysteresis of the liquid temperature.....	91
14.5.9	Resetting the default values of all the liquid temperature parameters .....	91
<b>14.6</b>	<b>Setting the parameters of the liquid velocity.....</b>	<b>92</b>
14.6.1	Giving a user defined name to the measured liquid velocity.....	92

14.6.2	Activating the damping of the liquid velocity values and selecting a predefined damping level .....	92
14.6.3	Activating a user-defined damping of the liquid velocity values .....	94
14.6.4	Deactivating the damping of the liquid velocity values .....	95
14.6.5	Activating the monitoring of the liquid velocity.....	95
14.6.6	Deactivating the monitoring of the liquid velocity.....	96
14.6.7	Changing the error limits, the warning limits and the hysteresis of the liquid velocity.....	97
14.6.8	Resetting the default values of the error limits, the warning limits and the hysteresis of the liquid velocity.....	97
14.6.9	Resetting the default values of all the liquid velocity parameters .....	98
<b>14.7</b>	<b>Setting the parameters of the totalizers.....</b>	<b>99</b>
14.7.1	Giving a user defined name to each totalizer .....	99
14.7.2	Selecting the counting direction of each totalizer .....	99
14.7.3	Activating the monitoring of each totalizer value.....	100
14.7.4	Deactivating the monitoring of each totalizer .....	101
14.7.5	Changing the error limits, the warning limits and the hysteresis of each totalizer ...	101
14.7.6	Resetting the default values of the error limits, the warning limits and the hysteresis of each totalizer .....	102
14.7.7	Enabling the user to start, stop or reset each totalizer.....	102
14.7.8	Disabling the user to start, stop or reset each totalizer .....	103
14.7.9	Starting a totalizer.....	103
14.7.10	Stopping a totalizer.....	103
14.7.11	Resetting each totalizer to a <b>Preset value</b> .....	104
14.7.12	Changing the <b>Preset value</b> for a totalizer reset .....	104
14.7.13	Resetting the overflow counter of a totalizer .....	105
14.7.14	Resetting all the parameters of a totalizer to the default values.....	105
<b>14.8</b>	<b>Setting the parameters of the density factor (optional feature).....</b>	<b>106</b>
14.8.1	What is the density factor? .....	106
14.8.2	Giving a user defined name to the measured density factor.....	106
14.8.3	Activating the damping of the density factor values and selecting a predefined damping level .....	107
14.8.4	Activating a user-defined damping of the density factor values .....	108
14.8.5	Deactivating the damping of the density factor values .....	109
14.8.6	Activating the monitoring of the density factor.....	110
14.8.7	Deactivating the monitoring of the density factor.....	110
14.8.8	Changing the error limits, the warning limits and the hysteresis of the density factor.....	111



14.8.9	Resetting the default values of the error limits, the warning limits and the hysteresis of the density factor.....	112
14.8.10	Setting the temperature compensation to measure the density factor .....	112
14.8.11	Setting the temperature compensation for a liquid other than water .....	113
14.8.12	Activating the temperature compensation for water .....	114
14.8.13	Resetting the default values of all the density factor parameters.....	114
14.8.14	Use case example of the density factor .....	115
<b>14.9</b>	<b>Setting the parameters of the acoustic transmission factor (optional feature).....</b>	<b>116</b>
14.9.1	What is the acoustic transmission factor?.....	116
14.9.2	Giving a user defined name to the measured acoustic transmission factor.....	117
14.9.3	Activating the damping of the acoustic transmission factor and selecting a predefined damping level .....	117
14.9.4	Activating a user-defined damping of the acoustic transmission factor .....	119
14.9.5	Deactivating the damping of the acoustic transmission factor .....	120
14.9.6	Changing the error limits, the warning limits and the hysteresis of the acoustic transmission factor.....	120
14.9.7	Activating the monitoring of the acoustic transmission factor .....	121
14.9.8	Deactivating the monitoring of the acoustic transmission factor .....	122
14.9.9	Resetting the default values of the error limits, the warning limits and the hysteresis of the acoustic transmission factor .....	122
14.9.10	Resetting the default values of all the acoustic transmission factor parameters .....	123
<b>14.10</b>	<b>Diagnostics: monitoring special events in the process, on the sensor or on the electronics.....</b>	<b>123</b>
14.10.1	Enabling the diagnostics for special events in the process .....	127
14.10.2	Disabling the diagnostics for special events in the process.....	128
14.10.3	Enabling the diagnostics for special events on the electronics.....	128
14.10.4	Disabling the diagnostics for special events on the electronics.....	129
14.10.5	Enabling the diagnostics for special events on the sensor .....	129
14.10.6	Disabling the diagnostics for special events on the sensor .....	130
<b>14.11</b>	<b>Getting as accurate measurements of the volume flow rate or the liquid velocity as possible .....</b>	<b>131</b>
14.11.1	Activating the viscosity compensation for water like liquids .....	132
14.11.2	Activating the compensation for a liquid with a constant viscosity.....	132
14.11.3	Activating the compensation for a liquid with a linear viscosity compensation curve.....	133
14.11.4	Activating the compensation for a liquid with a quadratic viscosity compensation curve .....	134
14.11.5	Activating the compensation for a liquid with an inverse quadratic viscosity compensation curve .....	135

14.11.6	Resetting the default values of the viscosity compensation parameters .....	135
<b>14.12</b>	<b>Setting the refresh time .....</b>	<b>136</b>
14.12.1	Use case of the refresh time.....	136
14.12.2	Changing the refresh time .....	136
<b>15</b>	<b>SAW SENSOR - DIAGNOSTICS.....</b>	<b>137</b>
15.1	Reading out the generated events related to the device .....	137
15.2	Reading out the flow direction that has been set .....	137
15.3	Reading out the temperatures of the electronic boards and of the liquid .....	137
15.4	Reading out the refresh time that has been set .....	138
15.5	Reading out the operating hours of the device .....	138
15.6	Reading out the operating hours of the measurement board.....	138
15.7	Reading out the diagnostics related to the output values .....	139
15.8	Reading out the diagnostics events that occurred in the process.....	139
15.9	Reading out the diagnostics events that occurred on the electronics .....	139
15.10	Reading out the diagnostics events that occurred on the sensor .....	140
15.11	Reading out the diagnostics related to the monitored limits.....	140
15.12	Reading out if a process value is in the monitored range.....	140
<b>16</b>	<b>SAW SENSOR - MAINTENANCE .....</b>	<b>141</b>
16.1	User levels of the editable menu items .....	141
16.2	Default settings .....	141
16.3	Reading out device information .....	141
16.3.1	Reading out the order numbers of the device, the transmitter board and the measurement board.....	141
16.3.2	Reading out the serial numbers of the device, the transmitter board and the measurement board.....	142
16.3.3	Reading out the hardware and software versions of the transmitter board and of the measurement board .....	142
16.3.4	Reading out the characteristics of the measurement tube.....	142
16.3.5	Checking the correct operation of the sensor .....	143
16.3.6	Reading out the calibration date at the manufacturer .....	144
16.3.7	Reading out the fluid type and the fluid temperature during calibration at the manufacturer .....	145
16.3.8	Reading out the raw measured value of the volume flow rate.....	145
<b>16.4</b>	<b>Setting the direction of the flow .....</b>	<b>145</b>

16.5	Calibrating the offset value of the flow zero point.....	146
16.6	Setting the offset value of the flow zero point.....	147
16.7	Setting the K factor.....	147
16.8	Calibrating the K factor by using a teach-in procedure .....	148
16.8.1	Calibrating the K factor by using a teach-in procedure depending on the flow rate	148
16.8.2	Calibrating the K factor by using a teach-in procedure depending on a known volume.....	149
16.9	Resetting the flow rate calibration data to its default values.....	150
16.10	Setting the offset value of the liquid temperature .....	151
16.11	Calibrating the offset value of the liquid temperature .....	152
16.12	Resetting the offset of the liquid temperature to the default value .....	153
16.13	Resetting all the calibration data to its default values (standard measurement values).....	153
16.14	Setting the offset value of the density factor.....	154
16.15	Calibrating the offset value of the density factor .....	155
16.16	Setting the linearity value of the density factor.....	156
16.17	Setting the offset value of the acoustic transmission factor .....	156
16.18	Calibrating the offset value of the acoustic transmission factor .....	157
16.19	Setting the linearity value of the acoustic transmission factor.....	158
16.20	Resetting all the calibration data to the default values (additional measurement values) ...	158
16.21	Checking the correct behaviour of the device .....	159
16.21.1	Selecting the process values to be simulated .....	159
16.21.2	Checking the behaviour of the device by simulating an event.....	160
16.21.3	Stopping the simulation of process values and events.....	160
17	OUTPUTS - PARAMETER .....	161
17.1	Default settings .....	161
17.2	Changing the type of an output.....	161
17.3	Setting the parameters of an analogue output.....	162
17.3.1	Changing the process value and the process value range associated to an analogue output.....	162
17.3.2	Selecting the damping level of the values transmitted on an analogue output.....	163
17.3.3	Configuring the behaviour of an analogue output depending on the status of the device .....	164
17.4	Disabling an analogue output .....	165

<b>17.5</b>	<b>Setting the parameters of a digital output.....</b>	<b>165</b>
17.5.1	Configuring a digital output as an on/off output.....	167
17.5.2	Configuring a digital output as an output with switching thresholds .....	168
17.5.3	Configuring a digital output as a frequency output.....	169
17.5.4	Configuring a digital output as a pulse output .....	170
<b>17.6</b>	<b>Resetting all the parameters of an output to default values.....</b>	<b>171</b>
<b>17.7</b>	<b>Resetting all the parameters of all the outputs to the default values.....</b>	<b>171</b>
<b>18</b>	<b>OUTPUTS - DIAGNOSTICS.....</b>	<b>172</b>
18.1	Analogue output: reading out the current status and the values of the current.....	172
18.2	Digital output: reading out the mode, the current status and the current value.....	172
<b>19</b>	<b>OUTPUTS - MAINTENANCE.....</b>	<b>173</b>
19.1	Calibrating an analogue output.....	173
19.2	Checking the correct operation of an analogue output .....	174
19.3	Resetting the calibration data of an analogue output to the default values .....	174
19.4	Resetting the calibration data of all the analogue outputs to the default values .....	175
19.5	Checking the correct operation of an on/off output or a threshold output.....	175
19.6	Checking the correct operation of a frequency output.....	176
19.7	Checking the correct operation of a pulse output .....	176
<b>20</b>	<b>MAINTENANCE AND TROUBLESHOOTING .....</b>	<b>177</b>
20.1	Safety instructions .....	177
20.2	Information on returning the device to the manufacturer or to the reseller .....	178
20.3	Cleaning the outer surface of the device.....	178
20.4	Cleaning In Place (CIP) of the device.....	178
20.5	Sterilisation In Place (SIP) of the device .....	179
20.6	Troubleshooting when a message is displayed.....	180
20.7	Messages when setting wrong parameters.....	181
20.7.1	Kinematic viscosity $\leq 0$ . Check the flow viscosity compensation's parameters .....	181
<b>20.8</b>	<b>Messages due to device internal diagnostics .....</b>	<b>181</b>
20.8.1	Message "Overvoltage detected" .....	181
20.8.2	Message "Undervoltage detected" .....	182
20.8.3	Message "Voltage is above the warning limit" .....	182

20.8.4	Message "Voltage is below the warning limit" .....	182
20.8.5	Message "Battery voltage is below the warning limit" .....	183
20.8.6	Message "bùS event: bus connection lost / not available" .....	183
20.8.7	Message "Overtemperature detected" .....	183
20.8.8	Message "Undertemperature detected" .....	184
20.8.9	Message "Temperature is above the warning limit" .....	184
20.8.10	Message "Temperature is below the warning limit" .....	184
20.8.11	Message "Internal message store overflow" .....	185
20.8.12	Message "No signals from interdigital transducer" .....	185
20.8.13	Message "No temperature sensor detected" .....	185
20.8.14	Message "Pipe characteristics have changed: check limits values" .....	185
20.8.15	Message "Measure board is in boot starter mode, no firmware found n°1" .....	186
20.8.16	Message "Data returned by the measurement PCB is invalid n°1" .....	186
20.8.17	Message "Communication between transmitter PCB and measurement PCB has been interrupted n°x" .....	186
20.8.18	Message "The measurement board bootloader operation failed n° 1" .....	186
20.8.19	Message "An error occurred during communication" .....	187
20.8.20	Message "Max. flow rate" .....	187
20.8.21	Message "Max temperature" .....	187
20.8.22	Message "Totalizer 1 stopped" or "Totalizer 2 stopped" .....	187
20.8.23	Message "Totalizer 1 started" or "Totalizer 2 started" .....	188
<b>20.9</b>	<b>Messages due to calibration or simulation</b> .....	<b>188</b>
20.9.1	Message "Calibration result out of range" .....	188
20.9.2	Message "Zero calibration cancelled, the flow rate is higher than 5% of full scale" .....	188
20.9.3	Message "Calibration cancelled" .....	189
20.9.4	Message "Calibration cancelled, the flow rate is less than 5% of the full scale" ....	189
20.9.5	Message "Resulting K factor is less than 0.8 or higher than 1.2" .....	189
20.9.6	Message "Resulting offset is higher than 10 °C, 18 °F" .....	189
20.9.7	Message "Test mode activated" .....	190
20.9.8	Message "Simulation mode active" .....	190
<b>20.10</b>	<b>Messages due to the monitoring of process values</b> .....	<b>190</b>
20.10.1	Message "Flow rate too high" .....	190
20.10.2	Message "Flow rate too low" .....	191
20.10.3	Message "Temperature too high" .....	191
20.10.4	Message "Temperature too low" .....	192

20.10.5	Message "Value totalizer 1 too high" or "Value totalizer 2 too high" .....	192
20.10.6	Message "Value totalizer 1 too low" or "Value totalizer 2 too low" .....	193
20.10.7	Message "Fluid velocity too high" .....	193
20.10.8	Message "Fluid velocity too low" .....	194
20.10.9	Message "Density factor too high" .....	194
20.10.10	Message "Density factor too low" .....	195
20.10.11	Message "Acoustic transmission factor too high" .....	195
20.10.12	Message "Acoustic transmission factor too low" .....	196
<b>20.11</b>	<b>Messages due to diagnostics events .....</b>	<b>196</b>
20.11.1	Message "Diagnostic is active" .....	196
20.11.2	Message "Diagnostic is inactive" .....	196
20.11.3	Message "Not totally filled" .....	197
20.11.4	Message "Liquid out of range" .....	197
20.11.5	Message "Unstable flow rate" .....	197
20.11.6	Message "Low flow cut off" .....	198
20.11.7	Message "Change of liquid" .....	198
20.11.8	Message "Backward flow" .....	198
20.11.9	Message "Sound conductivity out of range" .....	199
20.11.10	Message "AO1 open loop" or "AO3 open loop" .....	199
20.11.11	Message "AO1 Diag error" or "AO3 Diag error" .....	199
20.11.12	Message "DO2 overload" or "DO3 overload" .....	200
<b>21</b>	<b>SPARE PARTS AND ACCESSORIES .....</b>	<b>201</b>
<b>22</b>	<b>PACKAGING, TRANSPORT.....</b>	<b>202</b>
<b>23</b>	<b>STORAGE .....</b>	<b>202</b>
<b>24</b>	<b>DISPOSAL OF THE DEVICE.....</b>	<b>202</b>

# 1 ABOUT THESE OPERATING INSTRUCTIONS

The operating instructions describe the entire life cycle of the device. Please keep the operating instructions in a safe place, accessible to all users and any new owners.

The operating instructions contain important safety information.

Failure to comply with these instructions can lead to hazardous situations. Pay attention in particular to the chapters [3 Basic safety information](#) and [2 Intended use](#).

► Irrespective of the device version, the operating instructions must be read and understood.

## 1.1 Symbols used



### DANGER

Warns against an imminent danger.

► Failure to observe this warning results in death or in serious injury.



### WARNING

Warns against a potentially dangerous situation.

► Failure to observe this warning can result in serious injury or even death.



### CAUTION

Warns against a possible risk.

► Failure to observe this warning can result in substantial or minor injuries.

### NOTICE

Warns against material damage.



Indicates additional information, advice or important recommendations.



Refers to information contained in these Operating Instructions or in other documents.

► Indicates an instruction to be carried out to avoid a danger, a warning or a possible risk.

→ Indicates a procedure to be carried out.

A **highlighted term** is related to a menu or a menu item.

✔ Indicates the result of a specific instruction.

## 1.2 Definition

The term "device" used in these operating instructions always refers to the flowmeter Type 8098 FLOWave S.

The term "bÜS" (Bürkert system bus) used in this instruction stands for the communication bus developed by Bürkert and based on the CANopen protocol.

- For more information on the device via büS, see the English "Cabling guide for büS/EDIP" at [www.burkert.com](http://www.burkert.com).
- For more information on CANopen which is related to the device, refer to the operating instructions "CANopen Network configuration" at [www.burkert.com](http://www.burkert.com).

## 2 INTENDED USE

The flowmeter Type 8098 FLOWave S uses the Surface Acoustic Wave (SAW) measurement principle and is intended to measure the flow rate of liquids that have all the following characteristics:

- clean liquids
  - non emulsified liquids (homogeneous liquids)
  - liquids that are free of air bubbles
  - liquids that are free of gas bubbles
  - liquids that are free of solids.
- ▶ The device is not intended to measure the flow rate of liquids if gas bubbles are present, whatever the origin of the bubbles (air intake, cavitation, degassing...).
  - ▶ Use the device only as intended. Use of the device that does not comply with the instructions could present risks to people, nearby installations and the environment.
  - ▶ Properly transport, store, install and operate the device.
  - ▶ Use the device in compliance with the characteristics and the conditions of commissioning and use specified in the contractual documents and in the operating instructions.
  - ▶ Protect the device against electromagnetic interference, ultraviolet rays and, when installed outdoors, against the effects of climatic conditions.
  - ▶ Do not use the device without ATEX approval in a potentially explosive atmosphere.
  - ▶ Only operate a device in perfect working order.

### 2.1 Device with ATEX approval



#### **DANGER!**

**Risk of explosion in the event of improper use of the device in potentially explosive areas.**

- ▶ Observe the specifications of the ATEX-conformity certificate.
- ▶ Observe the specifications given in the ATEX supplement for Type 8098 FLOWave S. The supplement is available at [www.burkert.com](http://www.burkert.com)

The ATEX approval is only valid if the device is used as described in the ATEX supplement.

If unauthorized changes are made to the device, then the ATEX approval becomes invalid.



### 3 BASIC SAFETY INFORMATION

This safety information does not take into account any contingencies or occurrences that may arise during installation, use and maintenance of the product.

The operating company is responsible for the respect of the local safety regulations, including staff safety.



#### **Risk of injury due to electrical voltage.**

- ▶ Before carrying out work on the system, disconnect the electrical power for all the conductors and isolate it.
- ▶ According to UL/EN 6101010-1:  
Double isolate all devices connected to the flow meter Type 8098 from the mains and note that these are limited energy circuits for all circuits connected to the flow meter Type 8098.
- ▶ Observe all applicable accident protection and safety regulations for electrical equipment.

#### **Risk of injury due to high pressure in the installation.**

- ▶ Before any intervention in the installation, stop the circulation of fluid, cut off the pressure and drain the pipe.
- ▶ Before any intervention in the installation, make sure there is no pressure in the pipe.
- ▶ Observe the dependency between the fluid temperature and the fluid pressure for the fitting used.

#### **If switched on for a prolonged time, risk of burns or fire due to hot device surfaces**

- ▶ Do not touch with bare hands.
- ▶ Keep the device away from highly flammable substances and fluids.

#### **Risk of burns due to high fluid temperatures.**

- ▶ Do not touch with bare hands the parts of the device that are in contact with the fluid.
- ▶ Use safety gloves to handle the device.
- ▶ Before opening the pipe, stop the circulation of fluid and drain the pipe.
- ▶ Before opening the pipe, make sure the pipe is completely empty.

#### **Risk of injury due to the nature of the fluid.**

- ▶ Respect the prevailing regulations on accident prevention and safety relating to the use of dangerous fluids.

**General dangerous situations**

To avoid injury, observe the following instructions:

- ▶ Do not use the device in explosive atmospheres.
- ▶ Do not use the device in an environment incompatible with the device materials.
- ▶ Only use fluids compatible with the device materials. Find the chemical resistance chart under [www.burkert.com](http://www.burkert.com)
- ▶ Do not subject the device to mechanical loads.
- ▶ Do not make any modifications to the device.
- ▶ Prevent any unintentional power supply switch-on.
- ▶ Only qualified and skilled staff may carry out installation and maintenance work.
- ▶ Ensure a defined or controlled restarting of the process after a power supply interruption.
- ▶ Observe the general technical rules.

**CAUTION****Risk of injury due to a heavy device.**

A heavy device can fall down during transport or during installation and cause injuries.

- ▶ Transport, install and dismantle a heavy device with the help of another person.
- ▶ Use appropriate tools.

**NOTICE**

Elements or components sensitive to electrostatic discharges.

This device contains electronic components that are sensitive to electrostatic discharges. They may be damaged if they are touched by an electrostatically charged person or object. In the worst case scenario, these components are instantly destroyed or disabled as soon as they are activated.

- ▶ To minimise or even avoid any damage caused by an electrostatic discharge, take all the precautions described in standard EN 61340-5-1.
- ▶ Also make sure that you do not touch any of the live electrical components.

## 4 GENERAL INFORMATION

### 4.1 Manufacturer's address and international contacts

To contact the manufacturer of the device, use the following address:

Bürkert SAS

Rue du Giessen

BP 21

F-67220 TRIEMBACH-AU-VAL

You may also contact your local Bürkert sales office.

The addresses of our international sales offices are available on the internet at:

[www.burkert.com](http://www.burkert.com)

### 4.2 Warranty conditions

The condition governing the legal warranty is the conforming use of the device in observance of the operating conditions specified in the Operating Instructions.

### 4.3 Information on the Internet

You can find the operating instructions and the technical data sheets for Type 8098 at:

[www.burkert.com](http://www.burkert.com)

## 5 DESCRIPTION

### 5.1 Structure

The Type 8098 flowmeter is made up of a Type SE91 transmitter and a Type S097 flow sensor.

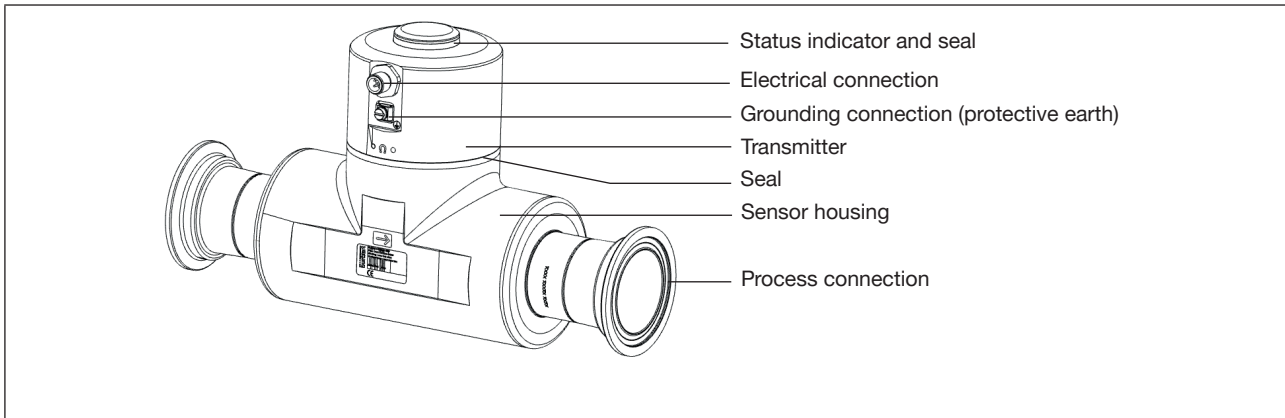

Figure 1: Description

#### 5.1.1 Transmitter variants

Variants:

- Without outputs
- With 2 outputs that can be configured as analogue or digital outputs

#### 5.1.2 Unlocking magnetic key

The device is delivered with a magnetic key to unlock the transmitter.



Figure 2: Unlocking magnetic key

## 5.2 Type label, adhesive label

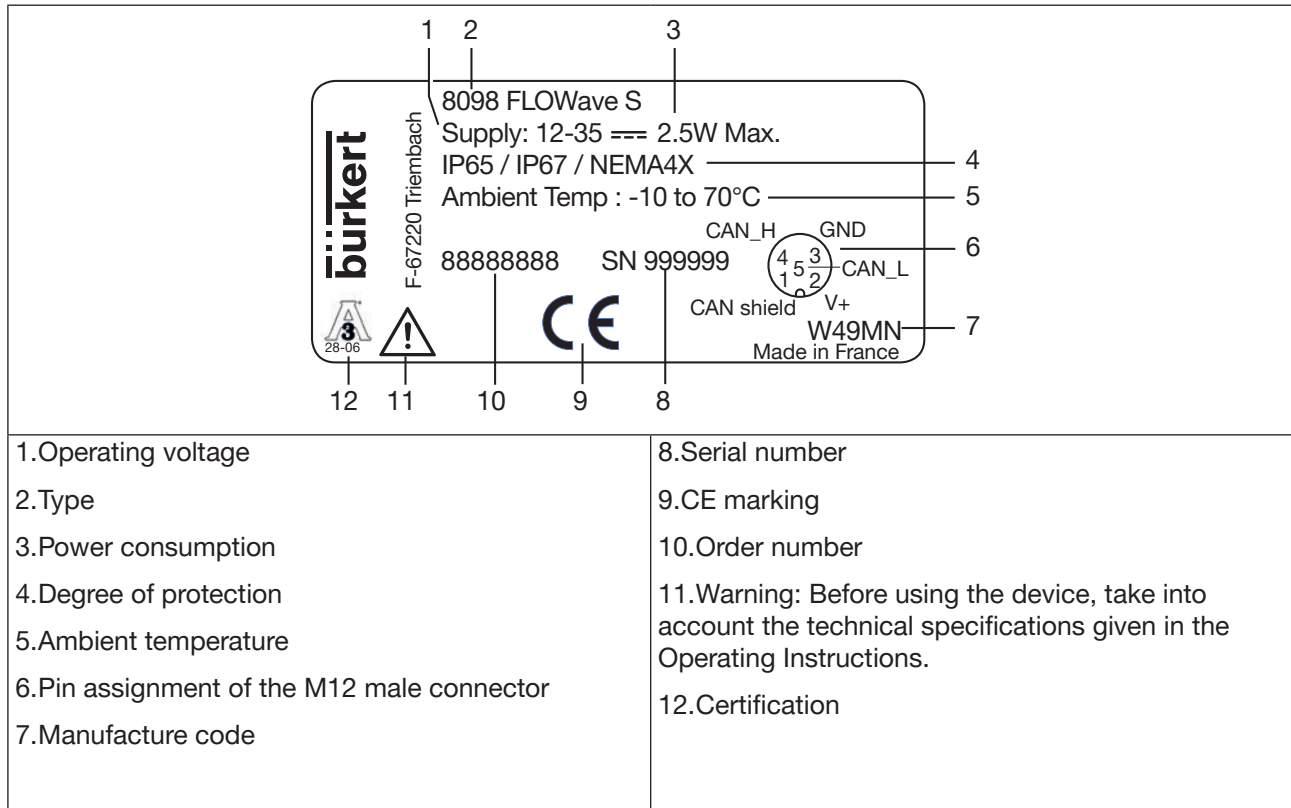

Figure 3: Type label of the Type 8098 flowmeter (example)

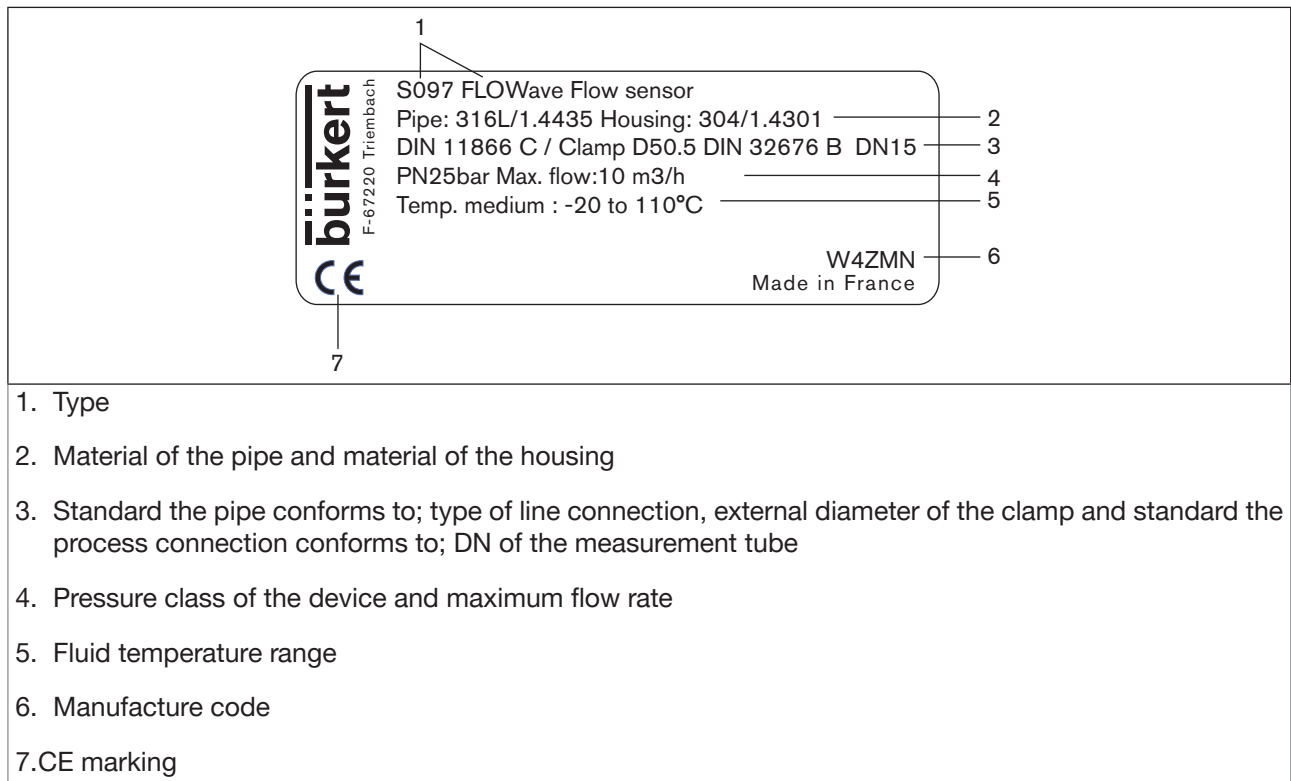

Figure 4: Type label of the Type S097 flow sensor (example)

### 5.3 Type label lasered

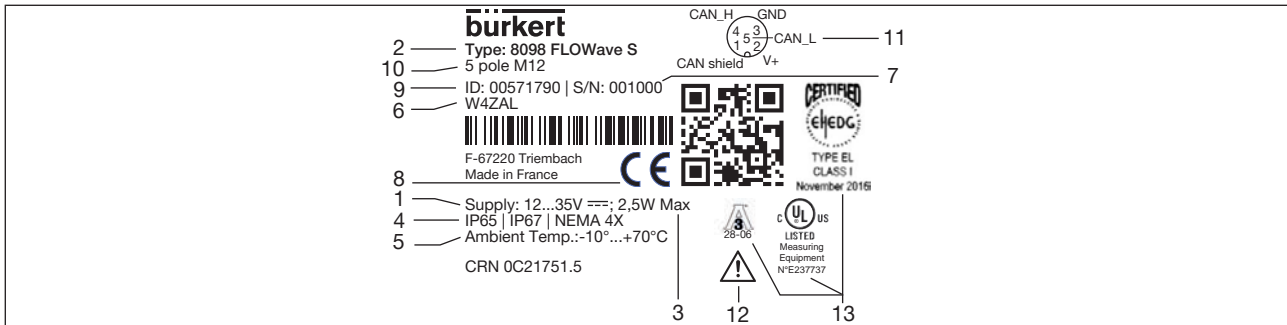

Figure 5: Type label flowmeter (example)

1. Operating voltage
2. Type
3. Power consumption
4. Degree of protection
5. Ambient temperature
6. Manufacture code
7. Serial number
8. CE marking
9. Order number
10. Male connector
11. Pin assignment of the M12 male connector
12. Warning: Before using the device, take into account the technical specifications given in the operating instructions.
13. Certification

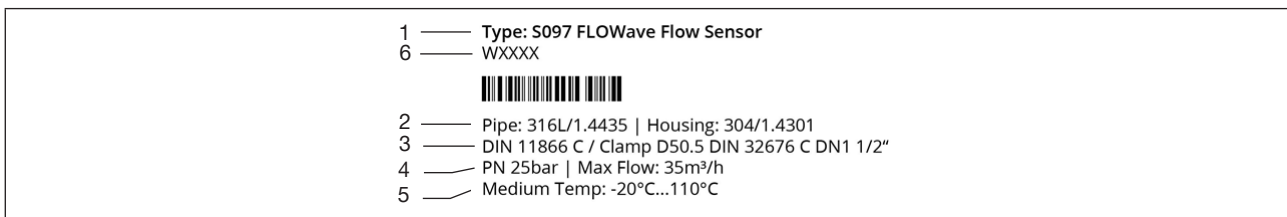

Figure 6: Type label flow sensor (example)

1. Type
2. Material of the pipe and material of the housing
3. Standard the pipe conforms to, type and standard of the process connection conforms to, DN of the measurement tube
4. Pressure class of the device and maximum flow rate
5. Fluid temperature range
6. Manufacture code
7. CE marking

## 5.4 Certification markings

Certification markings are either located on the Type label of the device or on separate labels.

## 5.5 Marking of the Unique Serial Number (USN)

The USN is marked on the side of the sensor. The USN is built with the order number and the serial number of the device.

## 5.6 Description of the status indicator

As a default setting, the status indicator shows:

- Diagnostic status signals according to NAMUR NE 107 (red, orange, yellow and blue)
- Status of diagnostics active or inactive
- Identification in the bus network

If several device status exist simultaneously, the device status with the highest priority is displayed. The priority is determined by the severity of the deviation from normal operation (red LED = failure, error or malfunction = highest priority).

Status indicator		Colour code (for a PLC)	Description	Meaning
Colour	Red	5	Failure, error, malfunction	Due to a malfunction of the device or its periphery, the measured values can be incorrect.
	Orange	4	Function check	Work is being carried out on the device; normal operation is therefore temporarily not possible
	Yellow	3	Out of specification	The ambient conditions or process conditions for the device are outside the permitted ranges. Device internal diagnostics point to problems in the device or with the process properties.
	Blue	2	Maintenance required	The device continues to measure but a function is temporarily restricted. → Do the required maintenance operation.
	Green	1	Diagnostics active	No event has been generated. Status changes are shown in colour. Messages are listed and possibly transmitted via any connected fieldbus.
	White	0	Diagnostics inactive	Device is switched on. Status changes are not shown. Messages are neither listed nor transmitted via any connected fieldbus.
Status	ON	-	Device is in operating state.	Device is in normal operation.
	Flashing rapidly	-	Identification	Serves as identification of a device in the bus network. The device was selected using the Bürkert Communicator software.

Table 1: Status indicator, colours and status in accordance with NAMUR NE 107, edition 2006-06-12

## 6 TECHNICAL DATA

### 6.1 Operating conditions

Ambient temperature	-10 – +70 °C
Air humidity	< 85%, non condensing
Operating altitude	Up to 2000 m above sea level
Operating mode	Continuous operation
Device mobility	Fixed device
Use	Indoor and outdoor (with protection against electromagnetic interference, ultraviolet rays and weather conditions)
Installation category	Category I according to UL/EN 61010-1
Degree of pollution	Degree 2 according to UL/EN 61010-1
Degree of protection	
according to IEC/EN 60529	IP65/IP67 <sup>1)</sup>
according to NEMA250	4X <sup>1)</sup>

---

1) If the device is wired and the transmitter is closed.  
 Not evaluated by UL.

### 6.2 Conformity

In accordance with the EU Declaration of conformity, the device is compliant with the EU Directives.

### 6.3 Standards and directives

The applied standards, which verify conformity with the EU Directives, can be found on the EU Type Examination Certificate and/or the EU Declaration of Conformity (if applicable).



### 6.3.1 Conformity to the Pressure Equipment Directive

- Make sure that the device materials are compatible with the fluid.
- Make sure that the DN and the PN of the device are adapted for the device.

The device conforms to Article 4, Paragraph 1 of the Pressure Equipment Directive 2014/68/EU under the following conditions:

Device used on a pipe (PS = maximum admissible pressure in bar; DN = nominal diameter of the pipe)

Type of fluid	Conditions
Fluid group 1, Article 4, Paragraph 1.c.i	DN ≤ 25
Fluid group 2, Article 4, Paragraph 1.c.i	DN ≤ 32 or PS x DN ≤ 1000 bar
Fluid group 1, Article 4, Paragraph 1.c.ii	DN ≤ 25 or PS x DN ≤ 2000 bar
Fluid group 2, Article 4, Paragraph 1.c.ii	DN ≤ 200 or PS ≤ 10 bar or PS x DN ≤ 5000 bar

Table 2: Pressure Equipment Directive

### 6.3.2 UL certification

The devices with variable key PU01 or PU02 are UL-certified devices and comply with the following standards:

- UL 61010-1
- CAN/CSA-C22.2 n°61010-1

Identification on the device	Certification	Variable key
	UL recognized	PU01
	UL listed	PU02

Table 3: UL certification

### 6.3.3 EHEDG certification

- EL class I
- The following versions are EHEDG certified:

Process connections	Diameters
Clamp <sup>2)</sup> connections according to ASME BPE (DIN 32676 series C)	3/8", 1/2", 3/4", 1", 1 1/2", 2"
Clamp connections according to DIN 11864-3 series C	1/2", 3/4", 1", 1 1/2", 2"
Flange connections according to DIN 11864-2 series C	1/2", 3/4", 1", 1 1/2", 2"
Clamp <sup>2)</sup> connections according to DIN 32676 series B	DN08, DN15 (except variants with a clamp diameter of 34.0 mm) DN25, DN40, DN50, DN65, DN80
Clamp <sup>2)</sup> connections according to DIN 32676 series A	DN08, DN15, DN25, DN40, DN50, DN65, DN80
Clamp connections according to DIN 11864-3 series A, DIN 11864-3 series B	DN08, DN15, DN25, DN40, DN50
Clamp <sup>2)</sup> connections according to SMS 3017 / ISO 2852 for pipes according to SMS 3008	DN25, DN40, DN50
Flange connections according to DIN 11864-2 series A, DIN 11864-2 series B	DN08, DN15, DN25, DN40, DN50
Threaded <sup>3)</sup> connections according to DIN 11851 series A	DN65, DN80

Table 4: EHEDG certification

→ To make sure you use EHEDG-compliant gaskets, refer to the "EHEDG Position Paper" available on the EHEDG website.



The manufacturer of the device does not supply any gaskets for the process connections.

2) The EHEDG compliance is only valid if used in combination with EHEDG-compliant gaskets from Combifit International B.V.

3) The EHEDG compliance is only valid if used in combination with EHEDG-compliant gaskets from: Kieselmann GmbH, Germany (ASEPTO-STAR k-flex upgrade gaskets) or Siersema Componenten Service (S.K.S.) B.V. (Netherlands SKS gaskets set DIN 11851 EHEDG with EPDM or FKM inner gasket)

## 6.4 Fluid data

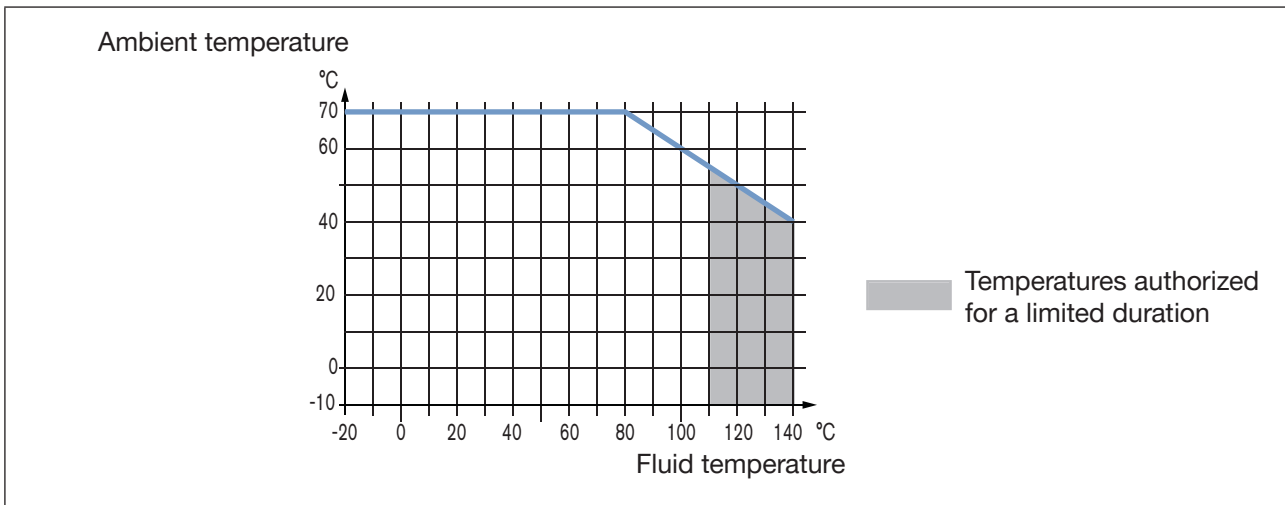

Figure 7: Dependency between the fluid temperature and the ambient temperature

Fluid temperature	-20 – +110 °C, with clamp process connections. Up to 140 °C for maximum 60 minutes for a sterilisation process. Maximum temperature gradient: 10 °C/s [measured by the sensor integrated in the device] The maximum fluid temperature can be restricted by the ambient operating temperature. Depending on the version of your device, see <a href="#">Figure 7</a> .
Type of fluids	Non-dangerous liquids according to Article 4, Paragraph 1 of Directive 2014/68/EU
Speed of sound in the fluid	
DN08, 3/8", 1/2"	1000 – 2000 m/s
≥ DN15, ≥ 3/4"	800 – 2300 m/s

Size of the process connection	Type of process connection	Standards the process connections conform to	PN
DN08, DN15, DN25	clamp	DIN 11864-3 series B DIN 32676 series A DIN 32676 series B	PN25
	flange	DIN 11864-2 series B	PN25
DN15, DN25	clamp	DIN 11864-3 series A	PN25
	flange	DIN 11864-2 series A	PN25
DN25	clamp	SMS 3017 / ISO 2852 for pipes according to SMS 3008	PN25
3/8", 1/2", 3/4", 1", 1 1/2"	clamp	ASME BPE (DIN 32676 series C)	PN25
1/2", 3/4", 1", 1 1/2"	clamp	DIN 11864-3 series C	PN25
	flange	DIN 11864-2 series C	PN25
DN40	clamp	DIN 11864-3 series B DIN 32676 series B	PN16
		DIN 11864-3 series A DIN 32676 series A SMS 3017 / ISO 2852 for pipes according to SMS 3008	PN25
	flange	DIN 11864-2 series B	PN16
		DIN 11864-2 series A	PN25
DN50	clamp	DIN 11864-3 series A DIN 11864-3 series B DIN 32676 series A DIN 32676 series B SMS 3017 / ISO 2852 for pipes according to SMS 3008	PN16
	flange	DIN 11864-2 series A DIN 11864-2 series B	PN16
2"	clamp	ASME BPE (DIN 32676 series C) DIN 11864-3 series C	PN16
	flange	DIN 11864-2 series C	PN16
DN65, DN80	clamp	DIN 32676 series A DIN 32676 series B	PN10
	threaded	DIN 11851 series A	PN10
ASME 2 1/2", 3"	clamp	DIN 32676 series C	PN10

Table 5: Nominal pressure (PN), depending on the pipe diameter, the type of process connections and the process connection standard

## 6.5 Measurement data

### Flow rate measurement

Measurement range	0 – 1.7 m <sup>3</sup> /h to 0 – 200 m <sup>3</sup> /h, depending on the DN of the sensor
Measurement deviation <sup>4) 5)</sup> for a flow rate between 10 % of the full scale and the full scale	±0.4 % of the measured value
Measurement deviation <sup>4) 5)</sup> for a flow rate between 1 % of the full scale and 10 % of the full scale	< ±0.08 % of the full scale
Repeatability <sup>5)</sup> for a flow rate between 10 % of the full scale and the full scale	±0.2 % of the measured value
Repeatability <sup>5)</sup> for a flow rate between 1 % of the full scale and 10 % of the full scale	±0.04 % of the full scale
Refresh time	Adjustable, see chpt. <a href="#">14.12 Setting the refresh time</a> .

### Temperature measurement

Measurement range	-30 – +140 °C
Measurement deviation <sup>4)</sup> for temperatures up to 100 °C	±1 °C
Measurement deviation <sup>4)</sup> for temperatures between 100 °C and 140 °C	±1.5 %
Refresh time	1 s

### Density factor measurement (optional feature)

Measurement range	0.8 – 1.3
Resolution	0.00001
Repeatability	±0.5 % of the measured value
Refresh time	Adjustable, see chpt. <a href="#">14.12 Setting the refresh time</a> .

### Acoustic transmission factor measurement (optional feature)

Measurement range	10 – 120 %
Resolution	0.01 %
Repeatability	±2 % of the measured value
Refresh time	Adjustable, see chpt. <a href="#">14.12 Setting the refresh time</a> .

4) "Measurement bias" as defined in standard JCGM 200:2012.

5) Determined under the following reference conditions: fluid = water, free of gas bubbles and solids; water and ambient temperatures = 23 °C ±1 °C (73.4 °F ±1.8 °F), device settings with their default values, short refresh time, while maintaining turbulent or laminar flow, applying the minimum inlet (40xDN) and minimum outlet (1xDN) straight pipe lengths, appropriate pipe dimensions.

## 6.6 Electrical data

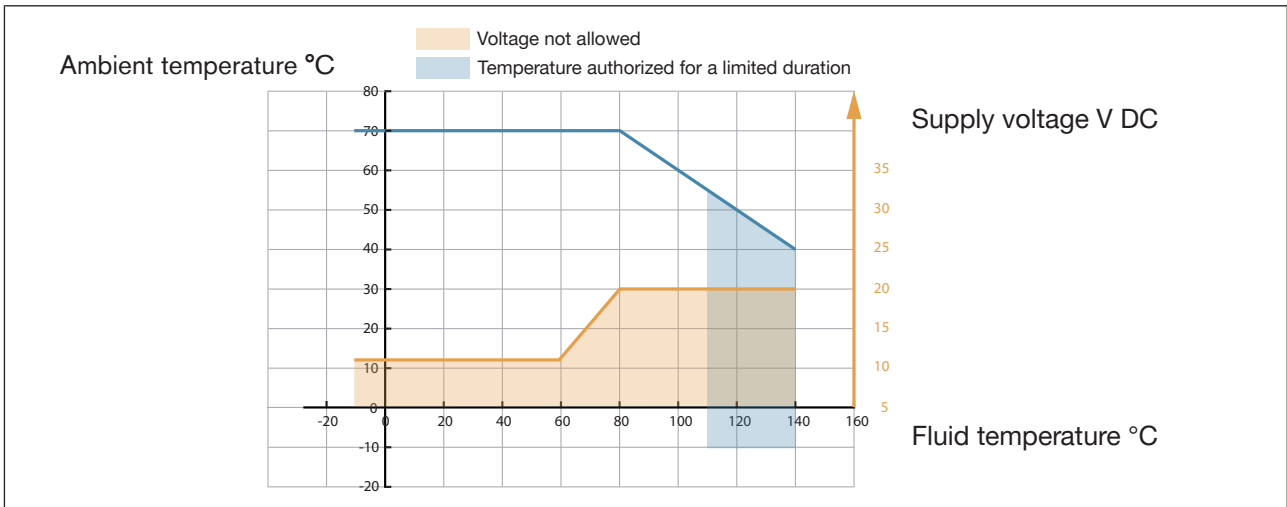

Figure 8: Minimum supply voltage depending on the ambient temperature and the fluid temperature

Connections	Circular plug-in connector
without outputs	M12 x 1, 5-pin
with outputs (2x AO/DO)	M12 x 1, 8-pin
Operating voltage	12 – 35 V DC $\pm 10\%$ The minimum supply voltage depends on the fluid temperature and the ambient operating temperature: depending on the variant of the device, see <a href="#">Figure 8</a> Filtered and regulated Safety Extra-Low Voltage circuit (SELV circuit) Limited Power Source (LPS) according to standards UL/EN 60950-1 or through a limited-energy circuit according to standards UL/EN 61010-1
Current consumption	max. 1 A
Power consumption	
without outputs	$\leq 2.5$ W
with outputs (2x AO/DO)	$\leq 5$ W
Polarity reversal	Protected
Outputs (variant)	Configurable as digital output or analogue output
Analog output	4 – 20 mA current 3.6 mA or 22 mA to indicate an error Uncertainty: $\pm 0.04$ mA Resolution: 0.8 $\mu$ A Open loop detection (diagnostics software function) Sink or source mode Galvanically isolated, passive Protected against polarity reversal Maximum loop impedance 1300 W at 35 V DC, 1000 W at 30 V DC, 700 W at 24 V DC, 450 W at 18 V DC

Digital output	Transistor NPN or PNP mode Mode: pulse on/off, threshold, frequency (configurable) 0 – 2000 Hz, 5 – 35 V DC, max. 700 mA Galvanically isolated, passive Overload information (diagnostics software function) Protected against overloads and polarity reversals
Communication interface	Connection to PC via USB-büS interface (see accessories) The büS connection of the variant with outputs is only for connection to the Bürkert Communicator for configuration and software updating of the device. Due to the lack of CAN shielding, conventional büS/ CANopen communication is not recommended.
Communication software	Bürkert Communicator

## 6.7 Mechanical data

Dimensions and weight	see data sheet
Materials	
Transmitter housing <sup>6)</sup>	Stainless steel 304 / 1.4301, outer surface finish Ra < 1.6 µm
Sensor body	Stainless steel 304 / 1.4301, outer surface finish Ra < 1.6 µm Stainless steel 316L / 1.4435, outer surface finish Ra < 1.6 µm
5-pin M12 male connector	Stainless steel
Blind plug	Stainless steel
Seals	
Sensor/transmitter	Silicone
Transmitter/status indicator	EPDM
Type label (adhesive labels)	Polyester
Sensor measurement tube <sup>7)</sup>	Stainless steel 316L / DIN 1.4435 with low delta-ferrite rate
Line connections <sup>7)</sup>	Stainless steel 316L / DIN 1.4435 with low delta-ferrite rate
Surface finish according to ISO 4288	
Measurement tube	
inner surface	Ra < 0.8 µm (30 µin) or Ra < 0.4 µm (15 µin) electro-polished
outer surface	Ra < 1.6 µm (excluding welding seams)
Sensor body	Ra < 1.6 µm (excluding welding seams)

6) The housing may have slight machining marks due to the manufacturing process. These marks do not affect the operation of the device and are not a manufacturing defect.

7) In contact with the fluid

## 7 INSTALLATION IN THE PIPE

### 7.1 Safety instructions



#### **DANGER**

##### **Risk of injury due to electrical voltage.**

- ▶ Before carrying out work on the system, disconnect the electrical power for all the conductors and isolate it.
- ▶ According to UL/EN 61010-1:  
Double isolate all devices connected to the flow meter Type 8098 from the mains and note that these are limited energy circuits for all circuits connected to the flow meter Type 8098.
- ▶ Observe all applicable accident protection and safety regulations for electrical equipment.
- ▶ Observe all applicable accident protection and safety regulations for electrical equipment.

##### **Risk of injury due to high pressure in the installation.**

- ▶ Before any intervention in the installation, stop the circulation of fluid, cut off the pressure and drain the pipe.
- ▶ Before any intervention in the installation, make sure there is no pressure in the pipe.
- ▶ Observe the dependency between the fluid temperature and the fluid pressure for the fitting used.

##### **If switched on for a prolonged time, risk of burns or fire due to hot device surfaces**

- ▶ Do not touch with bare hands.
- ▶ Keep the device away from highly flammable substances and fluids.

##### **Risk of burns due to high fluid temperatures.**

- ▶ Do not touch with bare hands the parts of the device that are in contact with the fluid.
- ▶ Use safety gloves to handle the device.
- ▶ Before opening the pipe, stop the circulation of fluid and drain the pipe.
- ▶ Before opening the pipe, make sure the pipe is completely empty.

##### **Risk of injury due to the nature of the fluid.**

- ▶ Respect the prevailing regulations on accident prevention and safety relating to the use of dangerous fluids.



#### **WARNING**

##### **Risk of injury due to non-conforming installation.**

- ▶ The electrical and fluid installations must only be carried out by qualified and authorized personnel with the appropriate tools.

##### **Risk of injury due to unintentional switch-on of the power supply or uncontrolled restart of the installation.**

- ▶ Take appropriate measures to avoid unintentional activation of the installation.
- ▶ Guarantee a set or controlled process restart after carrying out any device intervention.





### CAUTION

**Risk of injury due to a heavy device.**

A heavy device can fall down during transport or during installation and cause injuries.

- ▶ Transport, install and dismantle a heavy device with the help of another person.
- ▶ Use appropriate tools.

### NOTICE

**The device will be damaged if you use a tool to turn the transmitter.**

- ▶ Do not use a tool to turn the transmitter.

### NOTICE

**Risk of failure or risk of accelerated ageing of electrical components.**

- ▶ Observe the dependence between fluid temperature and ambient temperature.

## 7.2 Preparing the device before installation into the pipeline

The device is delivered as described in chpt. [5.1 Structure](#).

Before installing the device into the pipeline, you may change the position of the transmitter on the sensor. Refer to chpt. [7.2.1 Changing the position of the transmitter on the sensor](#).

## 7.2.1 Changing the position of the transmitter on the sensor

**!** These instructions are valid for all the versions of the device.

The Type SE98 transmitter can have four positions on the Type S091 flow sensor. See [Figure 9](#).

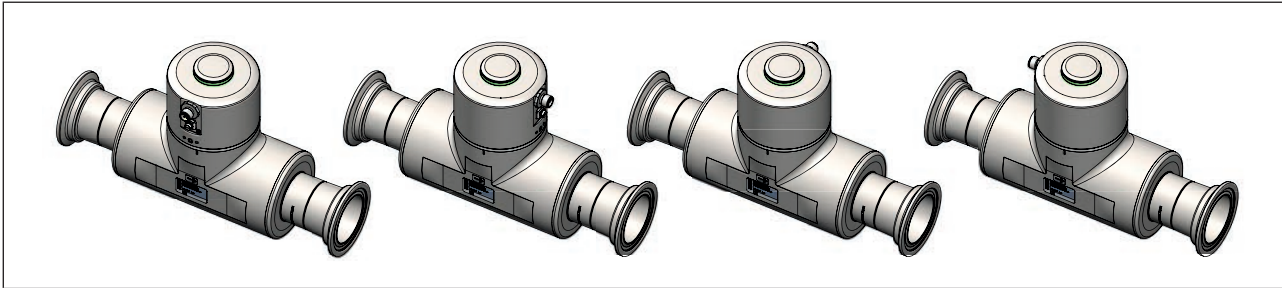





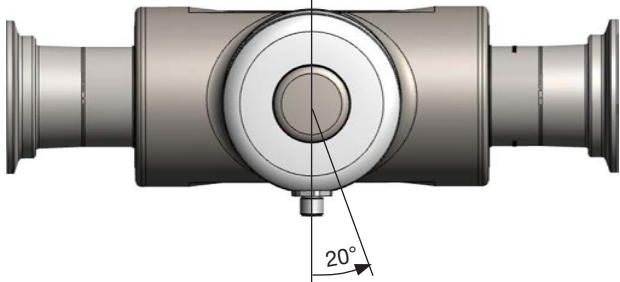

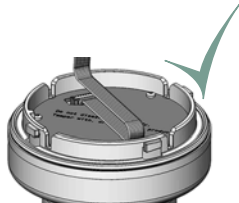
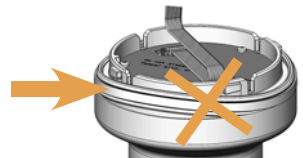
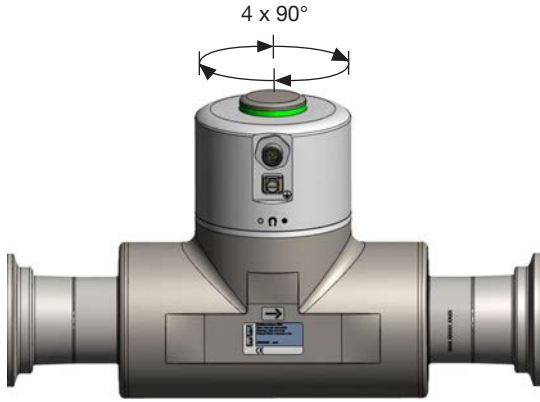
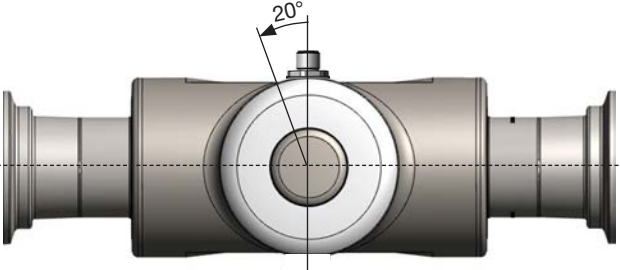
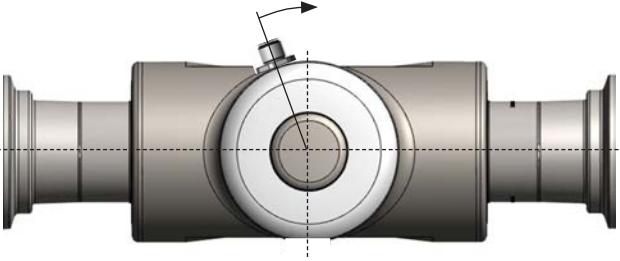

Figure 9: Possible positions of the transmitter SE91

 <p>The transmitter is locked</p>  <p>Magnetic key</p>  <p>The transmitter is unlocked</p>	<p>For safety reasons and to comply with standard UL 61010-1, the transmitter and the flow sensor are locked.</p> <p>→ Put the magnetic key on the  mark related to the transmitter.</p> <p>→ While the magnetic key is on the  mark, turn the transmitter by hand only from the locked position to the unlocked position.</p>
 <p>20°</p>	<p>→ Hold the flow sensor with one hand and, with the other hand, turn the transmitter by about 20 degrees counterclockwise.</p> <p>→  Lift the transmitter carefully because a cable connects the transmitter to the flow sensor.</p>
 	<p>→ If the seal is damaged, replace it. Apply a layer of lithium soap grease to the new seal before you put it in place.</p> <p>→ If the seal is not located in the groove, put it back in the groove.</p>

	<p>→ Turn the transmitter to the desired position.</p> <p>8. ⚠ Make sure the cable stays inside the transmitter.</p>
	<p>→ Turn the transmitter by about 20 degrees counterclockwise.</p> <p>→ Place the transmitter on the flow sensor.</p>
	<p>→ Screw the transmitter clockwise on the flow sensor until the transmitter is parallel or perpendicular to the axis of the pipeline.</p>

### 7.3 Recommendations for the installation into the pipeline

- Protect this device against electromagnetic interference, ultraviolet rays and, when installed outdoors, the effects of climatic conditions.
- Make sure the DN of the measurement tube is suited to the flow velocity: refer to the data sheet of the device, available at [www.burkert.com](http://www.burkert.com).
- Choose a location with enough free space to put the magnetic key against the symbol the on the device.
- For heavy devices or long pipelines, support the device and pipelines.
- Transport and install a heavy device with the help of another person and appropriate tool.
- If the temperature of the liquid is subject to fluctuations, ensure that the device can expand.
- Install the device upstream a valve or any equipment that changes the diameter or the direction of the pipeline.

Under reference conditions i.e. measuring fluid = water free from gas bubbles and solids, ambient and water temperature = 23 °C ±1 °C (73.4 °F ±1.8 F), and short refresh time, while maintaining turbulent or laminar flow profile, with the minimum inlet (40 x DN) and outlet (1 x DN) distances and the appropriate internal diameter of the pipes. Deviation from reference conditions can be adjusted through the use of a built-in correction K factor adjustment or Teach-in procedure.

- Install the device into either horizontal, oblique or vertical pipelines. But an installation in a vertical pipeline will be better to prevent air or gas bubbles inside the measurement area.
- For proper operation always ensure a totally filled measurement tube.
- To allow proper self-draining and to respect the 3A and EHEDG requirements, install the device into a pipeline with a minimum angle against the horizontal. See [Table 6](#).

Type of process connection	Standards the process connections conform to	Angle against the horizontal
clamp	DIN 32676 series A DIN 11864-3 series A SMS 3017 / ISO 2852 for pipes according to SMS 3008	DN15 to DN50: minimum 5°
		DN65 and DN80: minimum 3°
flange	DIN 11864-2 series A	DN15 to DN50: minimum 5°
clamp	ASME BPE (DIN 32676 series C) DIN 32676 series B DIN 11864-3 series B DIN 11864-3 series C	minimum 3°
flange	DIN 11864-2 series B DIN 11864-2 series C	minimum 3°
threaded	DIN 11851 series A	minimum 3°

Table 6: Minimum angle against the horizontal for proper self-draining

- If the pipeline is fitted with a thermal insulation, do not thermally insulate the measurement tube of the device to make sure that the temperature in the device is less than 70°. Refer to [Figure 10](#) and, for the minimum supply voltage, to chpt. [8.3](#).

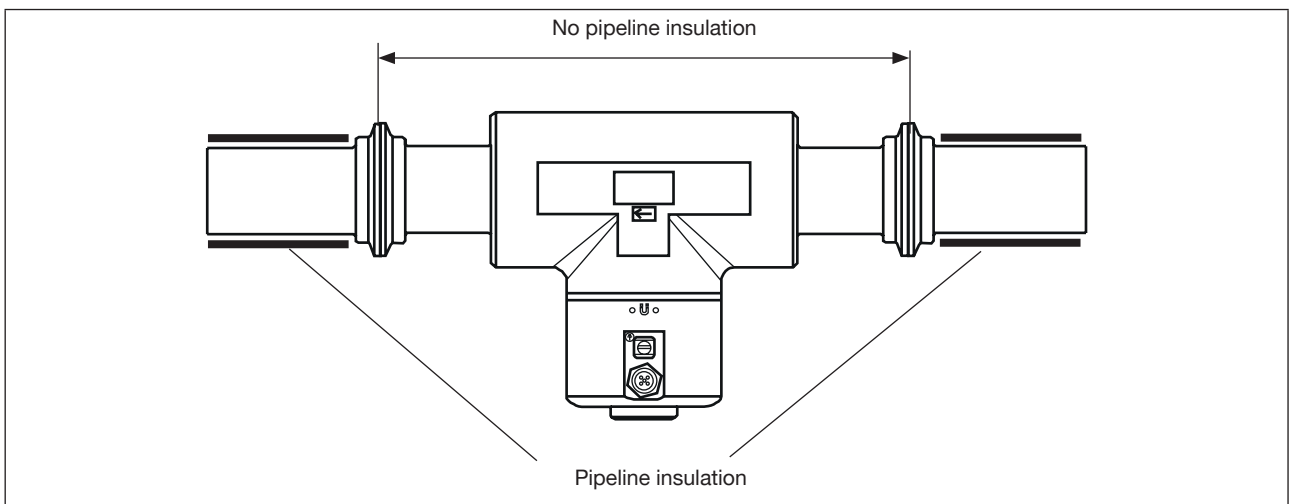

Figure 10: Thermal insulation of the pipeline

→ To make sure the internal temperature of the transmitter does not exceed the authorized maximum value, install the device as recommended in [Figure 11](#).

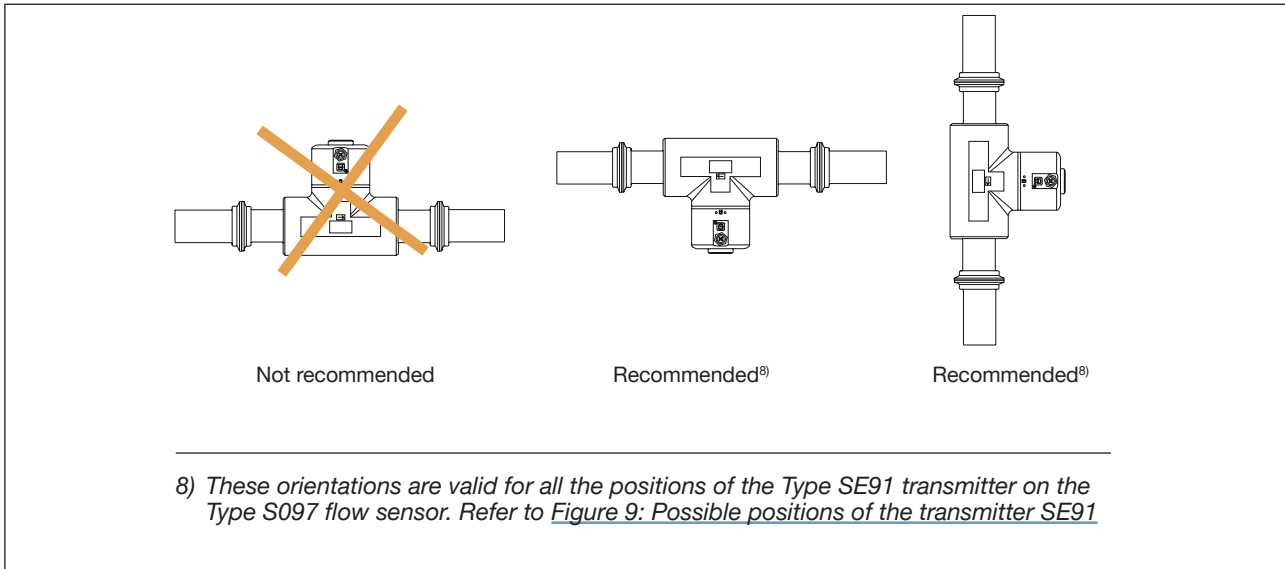

Figure 11: Orientation of a device to avoid effects of high liquid temperatures

## 7.4 Installing the device into the pipe

### CAUTION

Risk of injury due to a heavy device.

A heavy device can fall down during transport or during installation and cause injuries.

- ▶ Transport, install and dismantle a heavy device with the help of another person.
- ▶ Use appropriate tools.

### 7.4.1 Before installing the device into the pipe

- Prepare the device as described in [chpt. 7.2](#).
- Follow the recommendations given in [chpt. 7.3](#).

## 7.4.2 Installing a device with clamp connections

The manufacturer of the device does not supply any gaskets for the process connections.

- If the installation must be EHEDG-compliant and the device is fitted with clamp connections according to ASME BPE (DIN 32676 series C), DIN 32676 series A, DIN 32676 series B or SMS 3017 / ISO 2852 for pipes according to SMS 3008, then use EHEDG-compliant gaskets from Combifit International B.V.
- To make sure you use EHEDG-compliant gaskets, refer to the "EHEDG Position Paper" available on the EHEDG website.
- The clamp connections according to DIN 11864-3 series A, B and C are hygienic connections. You can use any gaskets that are adapted to the process.
- Make sure that the gaskets on the clamp connections are in good condition.
- Place gaskets adapted to the process (temperature, fluid type) in the grooves of the clamp connections.
- Attach the clamp connections to the pipe with clamp collars. Make sure that tightening the clamp collar does not create bulges at the gaskets.

## 7.4.3 Installing a device with flange connections

- The flange connections according to DIN 11864-2 series A, B and C are hygienic connections. You can use any gaskets that are adapted to the process.
- Make sure the gaskets on the flange connections are in good condition.
- Place gaskets adapted to the process (temperature, fluid type) in the flange connections.
- Use bolts with dimensions as given in the relevant flange standard and adapted to the process.
- Tighten the bolts to a torque as given in the relevant flange standard to fix the fitting to the pipe.

#### 7.4.4 Installing a device with threaded connections according to DIN 11851 series A.

Required connection parts according to DIN 11851 and corresponding DN:

- 2 weld liners
- 2 gaskets
- 2 nuts

For EHEDG conformity and threaded connections according to DIN 11851 Series A for pipes to DIN 11850:

→ Only use EHEDG-compliant gaskets:

ASEPTO-STAR K-flex Upgrade gaskets from Kieselmann GmbH, Germany

or

S.K.S. gasket set DIN 11851 EHEDG with EPDM or FKM inner gasket from Siersema Componenten Service (S.K.S.) B.V., Netherlands

Installation:

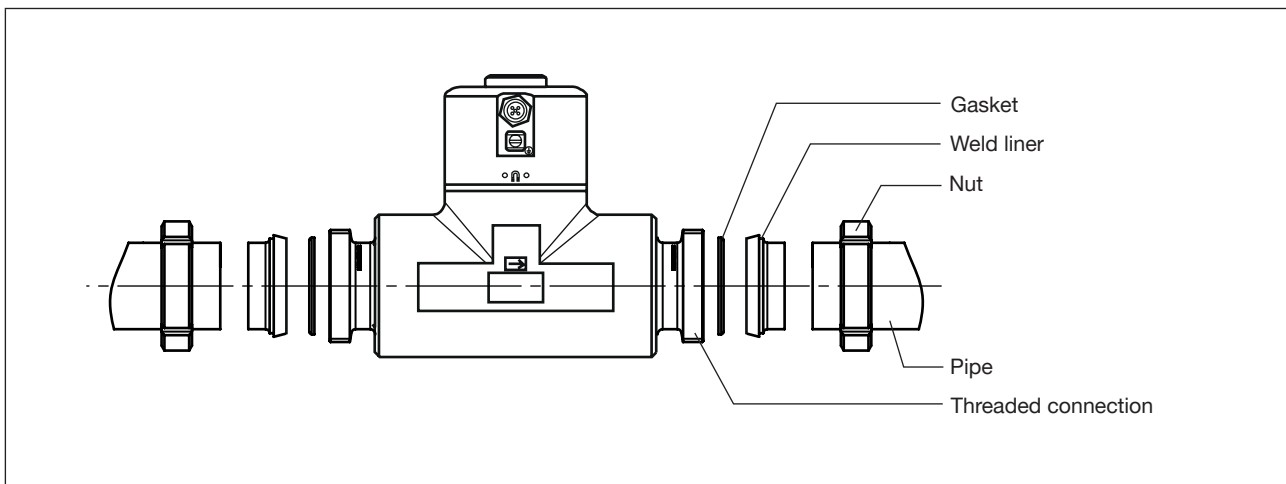

Figure 12: Installing with threaded connection

- Ensure that the gaskets are in good condition.
- Slide the nuts onto the pipes and weld the weld liners to the pipes.
- Place the gaskets adapted to the process (temperature, fluid type) between the threaded connection and the weld liner.
- Use the nuts to fix the weld liner to the threaded connections according to the standard

## 8 ELECTRICAL INSTALLATION

### 8.1 Safety instructions



#### **DANGER**

**Risk of injury due to electrical voltage.**

- ▶ Before carrying out work on the system, disconnect the electrical power for all the conductors and isolate it.
- ▶ According to UL/EN 6101010-1:  
Double isolate all devices connected to the flow meter Type 8098 from the mains and note that these are limited energy circuits for all circuits connected to the flow meter Type 8098.
- ▶ Observe all applicable accident protection and safety regulations for electrical equipment.

**Risk of injury due to high pressure in the installation.**

- ▶ Before any intervention in the installation, stop the circulation of fluid, cut off the pressure and drain the pipe.
- ▶ Before any intervention in the installation, make sure there is no pressure in the pipe.
- ▶ Observe the dependency between the fluid temperature and the fluid pressure for the fitting used.

**If switched on for a prolonged time, risk of burns or fire due to hot device surfaces.**

- ▶ Do not touch with bare hands.
- ▶ Keep the device away from highly flammable substances and fluids.

**Risk of burns due to high fluid temperatures.**

- ▶ Do not touch with bare hands the parts of the device that are in contact with the fluid.
- ▶ Use safety gloves to handle the device.
- ▶ Before opening the pipe, stop the circulation of fluid and drain the pipe.
- ▶ Before opening the pipe, make sure the pipe is completely empty.

**Risk of injury due to the nature of the fluid.**

- ▶ Respect the prevailing regulations on accident prevention and safety relating to the use of dangerous fluids.



#### **WARNING**

**Risk of injury due to non-conforming installation.**

- ▶ The electrical and fluid installations must only be carried out by qualified and authorized personnel with the appropriate tools.
- ▶ Fit a circuit breaker or a switch to the electrical installation of the building in which the device is installed.
- ▶ Install the circuit breaker or the switch in an easily accessible place.
- ▶ Identify the circuit breaker or the switch as the disconnecting component for the electrical power supply to the device.
- ▶ Install overload devices that are appropriate for electrical installation.
- ▶ Observe standard NF C 15-100 / IEC 60364.





### WARNING

Risk of injury due to unintentional switch on of the power supply or uncontrolled restart of the installation.

- ▶ Take appropriate measures to avoid unintentional activation of the installation.
- ▶ Guarantee a set or controlled process restart after carrying out any intervention on the device.



### CAUTION

Risk of injury due to a heavy device.

A heavy device can fall down during transport or during installation and cause injuries.

- ▶ Transport, install and dismantle a heavy device with the help of another person.
- ▶ Use appropriate tools.

### NOTICE

The device will be damaged if you use a tool to turn the transmitter.

- ▶ Do not use a tool to turn the transmitter.



- Use a high quality electrical power supply, filtered and regulated.
- Do not install the cables near high voltage or high frequency cables; if this cannot be avoided, observe a minimum distance of 30 cm.

## 8.2 Additional documentation

For more information on the device via bÜS, see the English "Cabling guide for bÜS/EDIP" at [www.burkert.com](http://www.burkert.com).

For more information on CANopen which is related to the device, refer to the operating instructions "CANopen Network configuration" at [www.burkert.com](http://www.burkert.com).

### 8.3 Connecting the device to a power supply

The device is wired in the factory to be easily energized through the M12 male connector.

- Variant without outputs: connect the device to a 12 – 35 V DC power supply through the 5-pin M12 male connector; Refer to chpt. 8.4.
- Variant with outputs: connect the device to a 12 – 35 V DC power supply through the 8-pin M12 male connector; Refer to chpt. 8.5.

The minimum voltage to be supplied depends on the fluid temperature and on the ambient operating temperature: see [Figure 13](#).

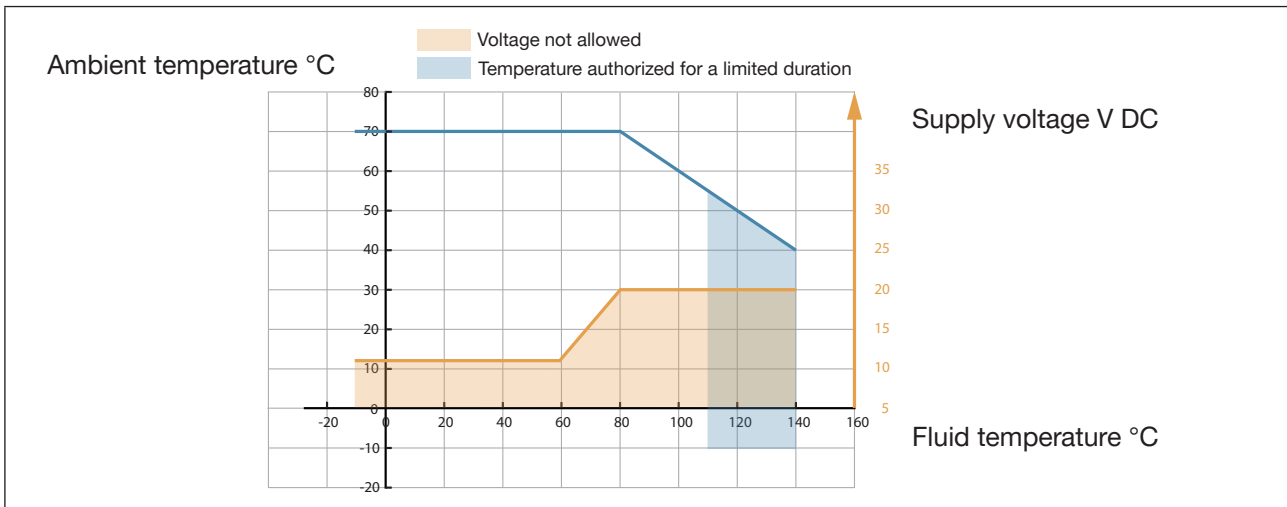

Figure 13: Minimum supply voltage depending on the ambient temperature and the fluid temperature

## 8.4 Connecting the device to a bÜS / CANopen network without outputs

→ For a correct operation of the device, use a 5-pin M12 female connector in stainless steel with shield connection.

The bÜS cable that is available from Bürkert has an external diameter of 8.2 mm.

→ Make sure that the bÜS cable passes through the 5-pin M12 female connector.

→ Observe the specifications for the cable and conductors, that are given by the manufacturer of the 5-pin female connector.

The 5-pin M12 male connector (A-coding) is used to connect the device:

- To a 12 – 35 V DC power supply and/or
- To the bÜS / CANopen network.

→ If the device is connected to a bÜS network or to a CANopen network and at one end of the bÜS network or of the CANopen network, either install a one or two 120 W termination resistors in the line or activate the device internal termination resistor: see chpt. [11.6.3](#). The bÜS or CANopen line must be adapted to reached 60 W.

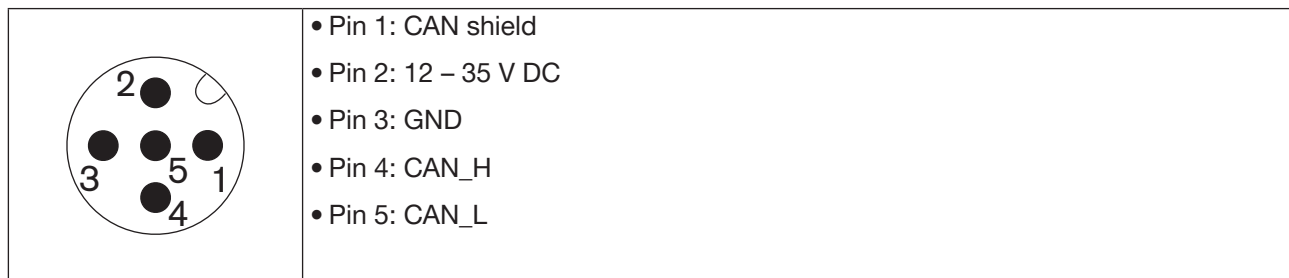

Figure 14: Pin assignment of the 5-pin M12 male connector

## 8.5 Connecting the device to a bÜS / CANopen network with outputs

→ For a correct operation of the device, use a 8-pin M12 female connector in stainless steel with shield connection.

→ Observe the specifications for the cable and conductors, that are given by the manufacturer.

The 8-pin M12 male connector (A-coding) is used to connect the device:

- To a 12 – 35 V DC power supply and/or
- To the bÜS / CANopen network
- Reading the outputs

→ If the device is connected to a bÜS network or to a CANopen network and at one end of the bÜS network or of the CANopen network, either install a one or two 120 W termination resistors in the line or activate the device internal termination resistor: see chpt. [11.6.3](#). The bÜS or CANopen line must be adapted to reached 60 W.

	<p>Pin 1: +24 V DC (12 – 35 V DC)</p> <p>Pin 2: GND</p> <p>Pin 3: CAN_L</p> <p>Pin 4: CAN_H</p> <p>Pin 5: AO/DO – (output 1)</p> <p>Pin 6: AO/DO + (output 1)</p> <p>Pin 7: AO/DO – (output 2)</p> <p>Pin 8: AO/DO + (output 2)</p>
---	---

Figure 15: Pin assignment of the 8-pin M12 male connector

**!** The bÜS connection of the variant with outputs is only for connection to the Bürkert Communicator for configuration and software updating of the device. Due to the lack of CAN shielding, conventional bÜS/ CANopen communication is not recommended.

## 8.6 Connecting the protective earth

- For a proper function of device always connect the yellow/green conductor to the grounding connection on the outer surface of the transmitter housing (see [Figure 16](#)).
- Use a ring cable lug for M4 screw.
- Tighten the M4 screw to a torque between 1.8 – 2 N·m (1.3 – 1.4 ft·lbf).

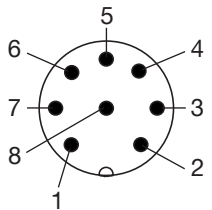
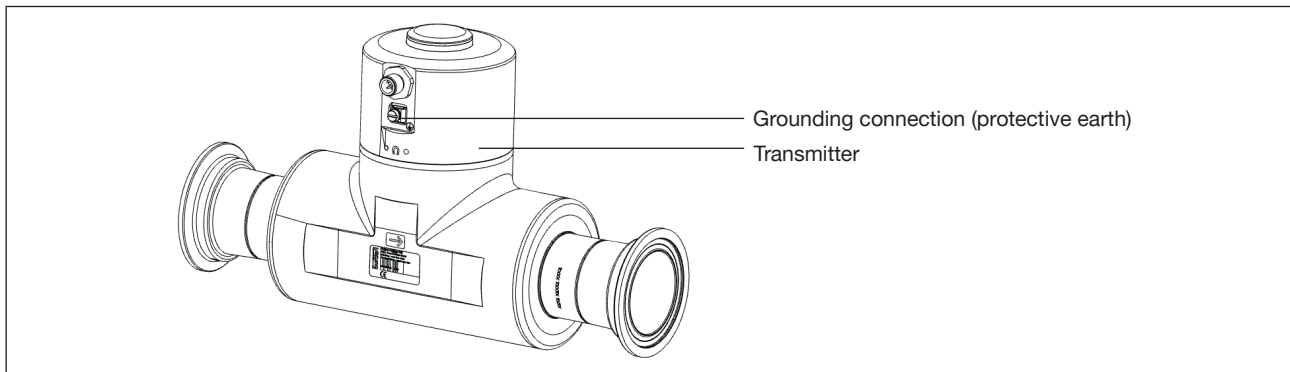

Figure 16: Grounding connection

## 9 HOW TO DO THE SETTINGS

The device settings can be made using the Bürkert Communicator software, which must be installed on a PC.

### 9.1 Safety instructions



#### WARNING

Risk of injury due to non-conforming adjustment.

Non-conforming adjustment could lead to injury and damage the device and its surroundings.

- ▶ The operators in charge of adjustment must have read and understood the contents of the operating instructions.
- ▶ In particular, observe the safety recommendations and intended use.
- ▶ The device/installation must only be adjusted by suitably trained staff.

### 9.2 Preparing the Bürkert Communicator software

#### 9.2.1 Connecting bÜS device with Bürkert Communicator

Required components (see Zubehör):

- Communications software: Bürkert Communicator for PC
- USB-bÜS interface
- bÜS adapter cable

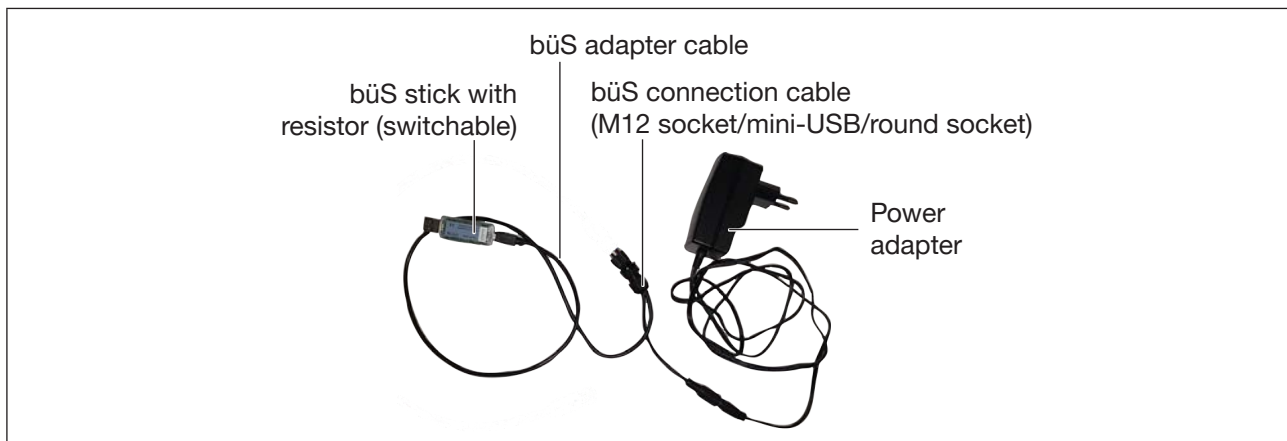



Figure 17: USB-bÜS-Interface and bÜS adapter cable

- Establish connection to PC with USB-bÜS interface and bÜS adapter cable.
- Start the Bürkert Communicator software.
- Click on  in the Bürkert Communicator software.
- Select **bÜS-Stick**.
- Select the port **Bürkert bÜS Stick**.
- Click on **Finish** and wait until the device symbol appears in the list of devices.
- Implementing settings.

## 9.3 Available login user levels

The following 4 login user levels are available to operate or adjust the device:

- the basic user level, which is the level with the least functions,
- the **Advanced User** user level,
- the **Installer** user level (default),
- the **Bürkert** user level.

By default, the device adjustment is not protected by passwords.

Table 7 shows the symbol displayed in the information bar, depending on the user level that is active on the device, and what can be done with each type of user level.





Symbol <sup>9)</sup>	User level	Description
No symbol	Basic user	<ul style="list-style-type: none"> <li>• No password is required.</li> <li>• The menu items with the symbol  enable read-only access.</li> <li>• Not all the menu items that are available with a higher user level are displayed.</li> </ul>
	<b>Advanced user</b>	<ul style="list-style-type: none"> <li>• Password required, if the password protection is active. Default password is 005678.</li> <li>• The menu items with the symbol  enable read-only access.</li> <li>• Not all the menu items that are available with a higher user level are displayed.</li> </ul>
	<b>Installer</b>	<ul style="list-style-type: none"> <li>• Password required, if the password protection is active. Default password is 001946.</li> <li>• This level is active by default (and by default, password protection is switched off).</li> <li>• All the available menu items can be adjusted.</li> </ul>
	<b>Bürkert</b>	<ul style="list-style-type: none"> <li>• Password required, if the password protection is active.</li> <li>• Only for Bürkert service.</li> </ul>

Table 7: Possible login user levels

9) Displayed in the information bar, only if the adjustment is protected through passwords.

→ If you have forgotten your passwords, you can restore the default passwords with the Type 8920 Bürkert Communicator software. Refer to the related Operating Instructions.

## 9.4 Default settings

You can find the default settings of the device in the CANopen supplement for the Type 8098 at [www.burkert.com](http://www.burkert.com)

→ Before making any changes to the settings, use the Bürkert Communicator software to print a pdf file with all the default settings of the device.

## 10 COMMISSIONING

### WARNING

Risk of injury due to non-conforming commissioning.

Non-conforming commissioning could lead to injuries and damage the device and its surroundings.

- ▶ Before commissioning, make sure that the staff in charge have read and fully understood the contents of the operating instructions.
- ▶ In particular, observe the safety recommendations and intended use.
- ▶ The device and the installation must only be commissioned by suitably trained staff.

### 10.1 Prerequisites

- ✓ The device is installed in the pipe.
  - ✓ The device is electrically installed and earthed.
    - The electrical installation of the device is performed. The device is correctly connected to the functional earth.
    - If your fluid is not water, then make sure that the optional features density factor measurement and acoustic transmission factor measurement are activated.
      - Switch on the operating voltage.
      - Connect the device to the Bürkert Communicator.
      - Before making any changes to the settings, use the Bürkert Communicator software to print a pdf file with all the default settings of the device.
      - If the liquid is not water, check the following values with the Bürkert Communicator to see if an accurate measurement of the flow rate is possible:
        - **Acoustic transmission factor** > 20 % ±5 %
        - **Dichtefaktor**: in the range 0,8...1,2
- Menu: **SAW sensor** -----▶ **Diagnostics** -----▶ **Output values** -----▶

### 10.2 Commissioning for measuring the flow rate or for filling containers

- Set the **Viscosity compensation** for the fluid:
  - If the fluid is water or the liquid has a kinematic viscosity between 0.5...2 mm<sup>2</sup>/s, set the **water** mode.
  - If the fluid is not water or has a kinematic viscosity outside the range 0.5...2 mm<sup>2</sup>/s, set the mode that is adapted to the fluid properties and process conditions.
- Make sure that the **Refresh time** is set to **Short**.
- Set the **Damping** of the volume flow rate:
  - Measuring a stable flow rate or determining the K-factor with **Teach-In by flow rate**: set the damping to **Medium**.
  - Filling a container in a time ≥ 30 s: set an appropriate damping.
  - Filling a container in a time < 30 s or for determining the K-factor with **Teach-In by flow rate**: set the damping to **None**.



- Make sure that the **Cut-off** function is active and set the value.
- Set the parameter **K factor**.
- Check the correct behaviour of the device with the **Simulation** function.
- Print a PDF file of the new settings of the device using the Bürkert Communicator.
- To obtain a reference state of the process values at commissioning:  
Select and record process values in the data logger. Export selected data in format (\*.edipdb). See operating instructions for type 8920.

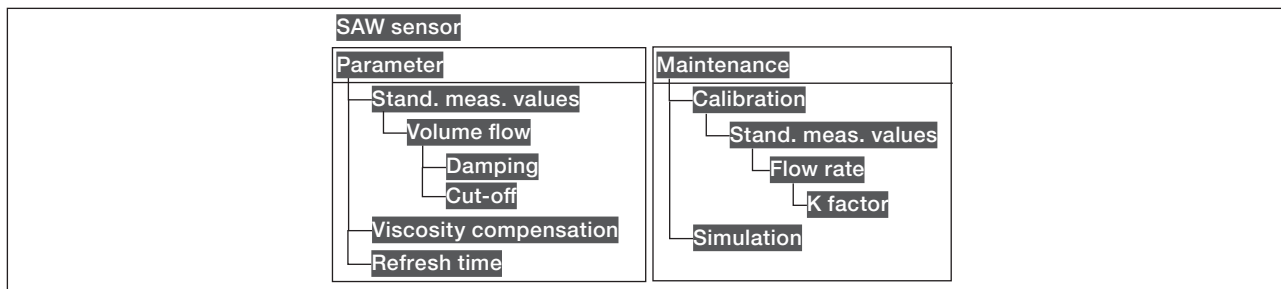

Figure 18: Menu

### 10.3 Commissioning for detecting a change of fluid in the pipe

- Adjust the **Damping** of the acoustic transmission factor depending on the application.
- Adjust the **Damping** of the density factor depending on the application.
- Check the correct behaviour of the device with the **Simulation** function.
- Print a PDF file of the new settings of the device using the Bürkert Communicator.
- To obtain a reference state of the process values at commissioning:  
Select and record process values in the data logger. Export selected data in format (\*.edipdb). See operating instructions for type 8920.

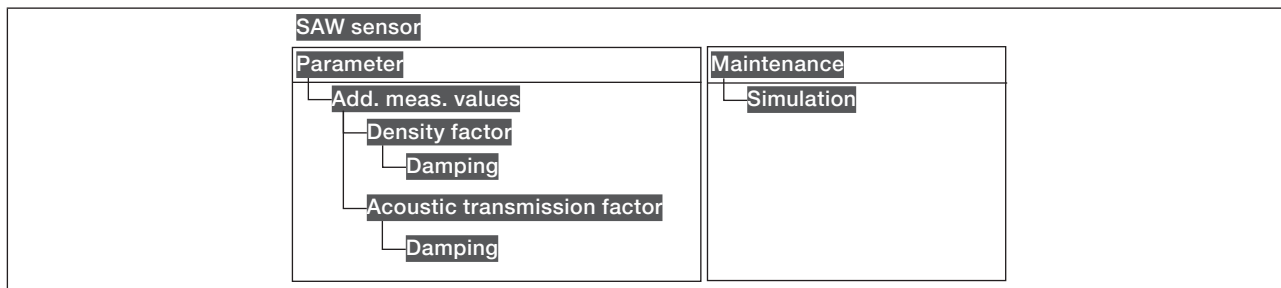

Figure 19: Menu

## 10.4 Commissioning for detecting bubbles in the pipe

- Adjust the **Damping** of the acoustic transmission factor depending on the application.
- Check the correct behaviour of the device with the **Simulation** function.
- Print a PDF file of the new settings of the device using the Bürkert Communicator.
- To obtain a reference state of the process values at commissioning:  
Select and record process values in the data logger. Export selected data in format (\*.edipdb). See operating instructions for type 8920.

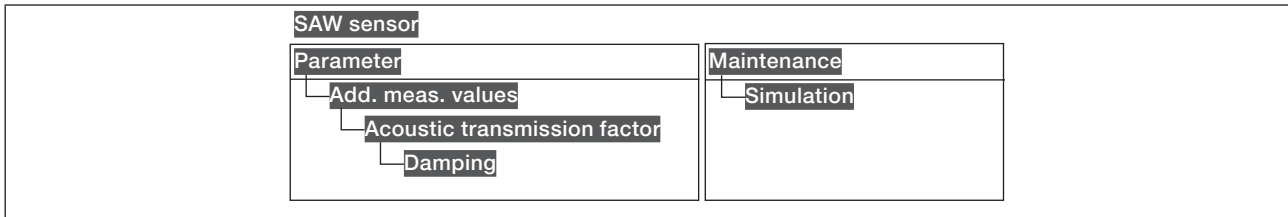

Figure 20: Menu

# 11 GENERAL SETTINGS - PARAMETER

## 11.1 Safety instructions



### WARNING

Risk of injury due to non-conforming adjustment.

Non-conforming adjustment could lead to injury and damage the device and its surroundings.

- ▶ The operators in charge of adjustment must have read and understood the contents of the Operating Instructions.
- ▶ In particular, observe the safety recommendations and intended use.
- ▶ The device/installation must only be adjusted by suitably trained staff.

## 11.2 User levels of the editable menu items

Menu item of the <b>General settings</b> - <b>Parameter</b> menu	Minimum user level
<b>Status LED</b>	<b>Installer</b>
<b>büS</b> - <b>Displayed name</b>	<b>Advanced user</b>
<b>büS</b> - <b>Location</b>	<b>Advanced user</b>
<b>büS</b> - <b>Description</b>	<b>Advanced user</b>
<b>büS</b> - <b>Advanced</b>	<b>Installer</b>
<b>Alarm limits</b> , except error limits	<b>Installer</b>
<b>Alarm limits</b> , error limits	<b>Bürkert</b>
<b>Quick start</b>	<b>Installer</b>
<b>Diagnostics</b>	<b>Installer</b>
<b>PDO Configuration</b>	<b>Installer</b>
<b>NaN Replacement</b>	<b>Installer</b>

## 11.3 Default settings

You can find the default settings of the device in the CANopen supplement for the Type 8098 at [www.burkert.com](http://www.burkert.com)

→ Before making any changes to the settings, use the Bürkert Communicator software to print a pdf file with all the default settings of the device.

## 11.4 Changing the operating mode of the status indicator or switching off the status indicator

By default, the status indicator gives information on the device status, according to the NAMUR NE 107 standard (**NAMUR mode**).

The following other operating modes of the status indicator are available:

- **Fixed color**: choose the permanent colour of the status indicator.
- **LED off**: the status indicator is always off.

### 11.4.1 Changing the operating mode of the status indicator

To change the operating mode of the status indicator, do the following:

→ Select the device in the navigation area.

→ **General settings**

→ **Parameter**

→ **Status LED** -----▶

→ Select the operating mode of the status indicator.

✔ The operating mode of the status indicator is changed.

### 11.4.2 Switching off the status indicator

To switch off the status indicator, do the following:

→ Select the device in the navigation area.

→ **General settings**

→ **Parameter**

→ **Status LED** -----▶

→ **LED off**.

✔ The status indicator is always off.

## 11.5 Setting the basic parameters for identifying the device on bÜS

The **Displayed name**, the **Location** and the **Description** allow you to clearly identify the device on bÜS.

### 11.5.1 Entering a name for the device

The entered name will be shown on any display (e.g. the Bürkert Communicator software) connected to bÜS.

To enter the name of the device that will be shown on any display connected to bÜS, do the following:

→ Select the device in the navigation area.

→ **General settings**

→ **Parameter**

→ **bÜS** -----> **Displayed name** ----->

→ Enter the name.

→ **Apply**

✔ The name is set.

### 11.5.2 Entering the location of the device

The entered location will be shown on any display (e.g. the Bürkert Communicator software) connected to bÜS.

To enter the information where the device is geographically located, do the following:

→ Select the device in the navigation area.

→ **General settings**

→ **Parameter**

→ **bÜS** -----> **Location** ----->

→ Enter the location.

→ **Apply**

✔ The location is set.

### 11.5.3 Entering a description for the device

The description allows you to precisely identify this device. To enter a description for the device, do the following:

- Select the device in the navigation area.
- **General settings**
- **Parameter**
- **büS** -----> **Description** ----->
- Enter the description (max. 19 characters).
- **Apply**
- ✓ The description is set.

## 11.6 Setting the advanced parameters for identifying the device connected to büS or to a CANopen fieldbus

### 11.6.1 Entering a unique name for the device



Only change the **Unique device name** of a device if 2 devices with the same name are connected to büS or to a CANopen fieldbus.

If the **Unique device name** of the device is changed, the participants on büS or to a CANopen fieldbus lose the link to the device. The link between the participants must then be restored.

The **Unique device name** of the device is used by the participants connected to büS or to a CANopen fieldbus.

To change the **Unique device name**, do the following:

- Select the device in the navigation area.
- **General settings**
- **Parameter**
- **büS** -----> **Advanced** ----->
- **Unique device name** ----->
- Enter the name.
- **Apply**
- ✓ The unique name is set.

## 11.6.2 Changing the transmission speed on the device

The transmission speed for the communication on the fieldbus (both bÜS or CANopen) must be the same for all the participants of the fieldbus.

By default, the transmission speed of the device is 500 kbit/s. This transmission speed is suited for a maximum cable length of 50 m.

If the cable length is higher, reduce the transmission speed of all the participants.

To change the transmission speed of the device, do the following:

→ Select the device in the navigation area.

→ **General settings**

→ **Parameter**

→ **bÜS** -----> **Advanced** ----->

→ **Baudrate** ----->

→ Choose the transmission speed.

The transmission speed of the device is changed. To take the transmission speed into account, restart the device.

## 11.6.3 Activating the device internal termination resistor

If the device is connected to a CANopen fieldbus or to bÜS, a 120 Ω termination resistor must be installed at each end of the fieldbus or of bÜS.

To avoid installing a physical termination resistor, the device has an internal 120 Ω termination resistor that can be activated if the device is installed at one end of bÜS.



- If you activate the device internal termination resistor, do not install a termination resistor at the same end of bÜS or of the CANopen fieldbus.
- Max. 2 120 Ω termination resistors can equip bÜS or a CANopen fieldbus.

To activate the device internal termination resistor, do the following:

→ Select the device in the navigation area.

→ **General settings**

→ **Parameter**

→ **bÜS** -----> **Advanced** ----->

→ **Termination resistor** ----->

→ **On**

The internal termination resistor is activated.

## 11.6.4 Deactivating the device internal termination resistor

If the device is not installed at the end of büS or of a CANopen fieldbus, deactivate the device internal termination resistor.



Max. 2 120 Ω termination resistors can equip büS or a CANopen fieldbus.

To deactivate the device internal termination resistor, do the following:

→ Select the device in the navigation area.

→ **General settings**

→ **Parameter**

→ **büS** -----> **Advanced** ----->

→ **Termination resistor** ----->

→ **Off**

✓ The internal 120 Ω termination resistor is deactivated.

## 11.6.5 Changing the address of the device connected to a CANopen fieldbus

The address of the device is used by büS or the CANopen fieldbus the device can be connected to.

- If the device is connected to büS, büS automatically addresses the device. By default, the address of the device on büS is 30.
  - If the device is connected to a CANopen fieldbus, the addresses are not set automatically.
- Make sure that each participant, including the device, connected to the CANopen fieldbus has a specific address.

If the device is connected to a CANopen fieldbus and another participant connected to the fieldbus has the same address, do the following to change the address of the device:

→ Select the device in the navigation area.

→ **General settings**

→ **Parameter**

→ **büS** -----> **Advanced** ----->

→ **büS address** ----->

→ Change the address of the device. Make sure you enter an address that is not already used on the same CANopen fieldbus.

✓ The address of the device is changed.

→ Start the device to take the new address into account. See chpt. [13.3.1 Restarting the device](#).



## 11.6.6 Setting the digital communication for büS or for a CANopen fieldbus

By default, the operating mode of the digital communication is set to **Standalone** and the measured process data (PDOs, process data objects) is not sent on a connected fieldbus.

The other operating modes of the digital communication are **büS** or **CANopen**.

If the device is connected to büS or to a CANopen fieldbus, do the following to change the operating mode of the digital communication:

→ Select the device in the navigation area.

→ **General settings**

→ **Parameter**

→ **büS** -----> **Advanced** ----->

→ **Bus mode** ----->

→ **büS** or **CANopen**.

→ Restart the device.

✓ The operating mode of the digital communication is büS or CANopen.

✓ If the operating mode of the digital communication is büS, the **CANopen status** is set to **Operational** (see chpt. [12.3.6](#)) and the PDOs are sent to büS.

✓ If the operating mode of the digital communication is CANopen, the **CANopen status** is set to **Pre-op** (see chpt. [12.3.6](#)) until the CANopen network master switches the device to **Operational**.

To stop the PDOs being sent to büS or to a fieldbus, see chpt. [11.6.7](#).

## 11.6.7 Stop sending the measured process data (PDOs) to bÜS or to the CANopen fieldbus

If the device is connected to bÜS or to a CANopen fieldbus and the **Bus mode** is set to **bÜS** or to **CANopen** and you want to temporarily stop sending the PDOs to bÜS or to the CANopen fieldbus, do the following:

→ Select the device in the navigation area.

→ **General settings**

→ **Parameter**

→ **bÜS** -----> **Advanced** ----->

→ **Bus mode** ----->

→ **Standalone**

→ Restart the device.

✓ The **CANopen status** is set to **Pre-op** and the PDOs are not sent to bÜS or to a CANopen fieldbus.

✓ The communication with the software Bürkert Communicator is still operational.

To enable the transmission of the PDOs to bÜS or to a fieldbus, see chpt. [11.6.6](#).

## 11.7 Monitoring the device supply voltage or the device temperature

The supply voltage of the device and the internal temperature of the device are monitored.

A monitored value can be:

- in the normal range (normal operating range)
- in the warning range
- in the error range

4 limit values are set, 2 error limits and 2 warning limits. The error limits can only be read but the warning limits can be adjusted.

[Figure 21](#) explains how the device reacts when the monitored value enters into another range (for example, from the normal range into the warning range). The reaction time depends on the hysteresis value and on whether the monitored value increases or decreases.

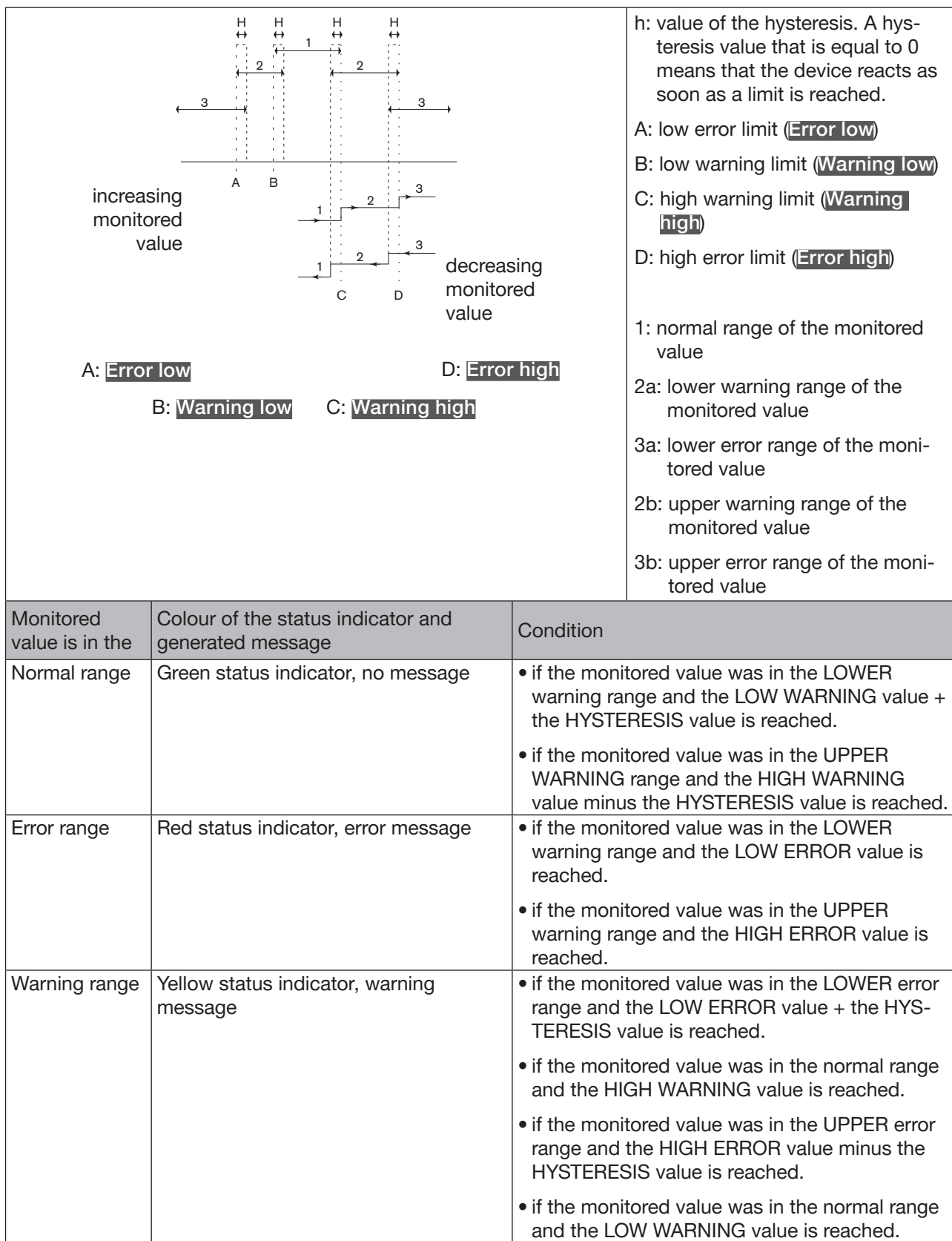

MAN 1000417092 EN Version: C Status: RL (released | freigegeben) printed: 21.05.2021

Figure 21: Operating principle of monitoring with a hysteresis

### 11.7.1 Reading out the 2 error limit values

To read out the limits the supply voltage of the device should be in, do the following:

- Select the device in the navigation area.
- **General settings**
- **Parameter**
- **Alarm limits** ----->
- **Supply voltage** or **Device temperature** ----->
- ✓ **Error high** or **Error low** can be read.

### 11.7.2 Changing the 2 warning limit values

To change the warning limits of the supply voltage or of the device temperature, do the following:

- Select the device in the navigation area.
- **General settings**
- **Parameter**
- **Alarm limits** ----->
- **Supply voltage** or **Device temperature** ----->
- **Warning high** or **Warning low** ----->
- Set the warning limit.
- ✓ The warning limits are changed.

### 11.7.3 Reading out the hysteresis value

To read out the hysteresis value, do the following:

- Select the device in the navigation area.
- **General settings**
- **Parameter**
- **Alarm limits** ----->
- **Supply voltage** or **Device temperature** ----->
- ✓ **Hysteresis** can be read.

## 11.8 Reading out the low warning limit for the voltage of the internal battery

The device has a small battery to store energy so that the time system can run for 7 days when the device is not powered.

To read out the value of the low warning limit, do the following:

→ Select the device in the navigation area.

→ **General settings**

→ **Parameter**

→ **Alarm limits** ----->

✓ **Warning battery voltage low** can be read.

## 11.9 Activating the diagnostics functions



### WARNING

Risk of injury due to non-conforming adjustment.

Non-conforming adjustment could lead to injuries and damage the device and its surroundings.

- ▶ The operators in charge of adjustment must have read and understood the contents of the Operating Instructions.
- ▶ In particular, observe the safety recommendations and intended use.
- ▶ The device/installation must only be adjusted by suitably trained staff.

By default, all the diagnostics events related to the process, the electronics or the sensor, the messages related to the monitoring of the process values (e.g. the flow rate) and the messages related to problems on the device and on büS are disabled.

To activate the diagnostics, do the following:

→ Activate the needed diagnostics events. See chpt. [14.10](#).

→ Activate the monitoring of the process variables that must be monitored. See chpt. [14.4.5](#), chpt. [14.5.5](#), chpt. [14.6.5](#), chpt. [14.7.3](#), chpt. [14.8.6](#), chpt. [14.9.7](#).

→ Select the device in the navigation area.

→ **General settings**

→ **Parameter**

→ **Diagnostics** ----->

→ Select **ON**

→ Restart the device.

✓ The needed diagnostics are active.

## 11.10 Disabling all the diagnostics

By default, all the diagnostics events related to the process, the electronics or the sensor, the messages related to the monitoring of the process values (e.g. the flow rate) and the messages related to problems on the device and on bus are disabled.

If the diagnostics are active on the device, do the following to disable them:

→ Select the device in the navigation area.

→ **General settings**

→ **Parameter**

→ **Diagnostics** ----->

→ Select **OFF**.

→ Restart the device.

All the diagnostics are disabled.

## 11.11 Set display (**NaN** or numerical value) if the process value cannot be measured

If the device cannot measure a process value, then the Bürkert Communicator will display **NaN** or a numerical value.

Whether to display the text **NaN** or a numerical value, do the following:

→ Select the device in the navigation area.

→ **General settings**

→ **Parameter**

→ NaN Replacement ----->

→ NaN Process values ----->

A list of process values is displayed.

To display the text **NaN**, do the following:

→ Deselect all the process values.

If the device cannot measure a selected process value, then the Bürkert Communicator displays NaN.

To display a numerical value, do the following:

→ Select the related process values.

→ **NaN Replacement value** ----->

→ Set the numerical value.

The numerical value is applied to all the selected process values.

If the device cannot measure a selected process value, then the Bürkert Communicator display the numerical value.

## 12 GENERAL SETTINGS - DIAGNOSTICS

### 12.1 User levels of the menu items

Menu item of the <b>General settings - Diagnostics</b> menu	Minimum user level
<b>Device status</b>	Basic user
<b>büS status - Receive errors</b>	<b>Advanced user</b>
<b>büS status - Receive errors max.</b>	<b>Advanced user</b>
<b>büS status - Transmit errors</b>	<b>Advanced user</b>
<b>büS status - Transmit errors max.</b>	<b>Advanced user</b>
<b>büS status - Reset error counter</b>	<b>Installer</b>

### 12.2 Reading out data related to the device

#### 12.2.1 Reading out the number of operating hours of the device

To read out the number of hours the device has already been operating, do the following:

- Select the device in the navigation area.
- **General settings**
- **Diagnostics**
- **Device status** -----▶

✓ The **Operating duration** of the device is displayed.

#### 12.2.2 Reading out the current value of the internal temperature of the device

To read out the current value of the internal temperature of the device, do the following:

- Select the device in the navigation area.
- **General settings**
- **Diagnostics**
- **Device status** -----▶

✓ The **Device temperature** of the device is displayed.

### 12.2.3 Reading out the minimum or the maximum value of the internal temperature of the device

To read out the minimum or the maximum value of the internal temperature of the device since the first power-up of the device, do the following:

- Select the device in the navigation area.
- **General settings**
- **Diagnostics**
- **Device status** ----->
- **Min./Max. values** ----->
- ✓ **Max. temperature** or **Min. temperature**: The minimum or the maximum value of the internal temperature of the device is displayed.

### 12.2.4 Reading out the current value of the supply voltage

To read out the current value of the supply voltage, do the following:

- Select the device in the navigation area.
- **General settings**
- **Diagnostics**
- **Device status** ----->
- ✓ The **Supply voltage** of the device is displayed.

### 12.2.5 Reading out the minimum or the maximum value of the supply voltage

To read out the minimum or the maximum value of the supply voltage since the last power-up of the device, do the following:

- Select the device in the navigation area.
- **General settings**
- **Diagnostics**
- **Device status** ----->
- **Min./Max. values** ----->
- ✓ **Max. supply voltage** or **Min. supply voltage**: The minimum or the maximum value of the supply voltage is displayed.



### 12.2.6 Reading out the current value of the current consumption of the device

To read out the value of the current consumption of the device, do the following:

→ Select the device in the navigation area.

→ **General settings**

→ **Diagnostics**

→ **Device status** -----▶

✔ The **Current consumption** of the device is displayed.

### 12.2.7 Reading out the minimum or the maximum value of the current consumption of the device

To read out the minimum or the maximum value of the current consumption of the device since the first power-up of the device, do the following:

→ Select the device in the navigation area.

→ **General settings**

→ **Diagnostics**

→ **Device status** -----▶

→ **Min./Max. values** -----▶

✔ **Max. current consumption** or **Min. current consumption**: The minimum or the maximum value of the current consumption of the device is displayed.

### 12.2.8 Reading out the number of device starts

To read out the number of restarts of the device, do the following:

→ Select the device in the navigation area.

→ **General settings**

→ **Diagnostics**

→ **Device status** -----▶

✔ **Device boot counter**: The number of device starts is displayed.

### 12.2.9 Checking whether the date and time are correct

To check whether the date and time are still correct on the device, do the following:

- Select the device in the navigation area.
- **General settings**
- **Diagnostics**
- **Device status** ----- ▶
- ✔ The **Current system time** is displayed.

### 12.2.10 Checking the voltage of the internal battery

The device has a small battery to store energy so that the time system can run for 7 days when the device is not powered.

To check the voltage of the internal battery, do the following:

- Select the device in the navigation area.
- **General settings**
- **Diagnostics**
- **Device status** ----- ▶
- ✔ The **Battery voltage** is displayed.

## 12.3 Reading out data related to būs

### 12.3.1 Reading out the number of current receive errors

To read out the number of current receive errors, do the following:

→ Select the device in the navigation area.

→ **General settings**

→ **Diagnostics**

→ **būs status** -----▶

✓ The **Receive errors** are displayed.

### 12.3.2 Reading out the maximum number of receive errors since the last power-up of the device

To read out the maximum number of receive errors, do the following:

→ Select the device in the navigation area.

→ **General settings**

→ **Diagnostics**

→ **būs status** -----▶

✓ The **Receive errors max.** are displayed.

### 12.3.3 Reading out the number of current transmit errors

To read out the number of current transmit errors, do the following:

→ Select the device in the navigation area.

→ **General settings**

→ **Diagnostics**

→ **būs status** -----▶

✓ The **Transmit errors** are displayed.

### 12.3.4 Reading out the maximum number of transmit errors since the last power-up of the device

To read out the maximum number of transmit errors, do the following:

→ Select the device in the navigation area.

→ **General settings**

→ **Diagnostics**

→ **büS status** ----->

✓ The **Transmit errors max.** are displayed.

### 12.3.5 Resetting the 2 maximum error counters

To reset the 2 maximum error counters, do the following:

→ Select the device in the navigation area.

→ **General settings**

→ **Diagnostics**

→ **büS status** ----->

→ **Reset error counter** ----->

→ **Confirm.**

✓ The 2 maximum error counters are reset.

### 12.3.6 Reading out whether the measured process data (PDO, process data object) is sent on büS or on the CANopen fieldbus

To read out whether the measured process data (PDO, process data object) is sent on büS or on the CANopen fieldbus, do the following:

→ Select the device in the navigation area.

→ **General settings**

→ **Diagnostics**

→ **büS status** ----->

✓ The **CANopen status** is displayed:

- If the CANopen status is **Operational**, the PDOs are sent to büS.
- If the CANopen status is **Pre-Op** (pre-operational), the PDOs are not sent on büS or on the CANopen fieldbus and a message is generated in the message list. For example, the **Pre-Op** status is active if the **Bus mode** is set to **Standalone** (see chpt. 11.6.7).

## 13 GENERAL SETTINGS - MAINTENANCE

### 13.1 User levels of the menu items

Menu item of the <b>General settings - Maintenance</b> menu	Minimum user level
<b>Device information</b>	Basic user
<b>Reset device</b>	<b>Installer</b>

### 13.2 Reading out some device information

#### 13.2.1 Reading out the displayed name of the device

To read out the displayed name of the device, do the following:

→ Select the device in the navigation area.

→ **General settings**

→ **Maintenance**

→ **Device information** ----->

✓ The **Displayed name** is displayed.

#### 13.2.2 Reading out the article number of the device

To read out the article number of the device, do the following:

→ Select the device in the navigation area.

→ **General settings**

→ **Maintenance**

→ **Device information** ----->

✓ The **Ident. number** is displayed.

#### 13.2.3 Reading out the serial number of the device

To read out the serial number of the device, do the following:

→ Select the device in the navigation area.

→ **General settings**

→ **Maintenance**

→ **Device information** ----->

✓ The **Serial number** is displayed.

### 13.2.4 Reading out the article number of the device software

To read out the article number of the device software, do the following:

- Select the device in the navigation area.
- **General settings**
- **Maintenance**
- **Device information** -----▶

✔ The **Software ident. number** is displayed.

### 13.2.5 Reading out the version number of the device software

To read out the version number of the device software, do the following:

- Select the device in the navigation area.
- **General settings**
- **Maintenance**
- **Device information** -----▶

✔ The **Software version** is displayed.

### 13.2.6 Reading out the version number of the bÜS software

To read out the version number of the bÜS software, do the following:

- Select the device in the navigation area.
- **General settings**
- **Maintenance**
- **Device information** -----▶

✔ The **bÜS version** is displayed.

### 13.2.7 Reading out the version number of the device hardware

To read out the version number of the device hardware, do the following:

- Select the device in the navigation area.
- **General settings**
- **Maintenance**
- **Device information** -----▶

✔ The **Hardware version** is displayed.

### 13.2.8 Reading out the Type number of the device

To read out the Type number of the device, do the following:

- Select the device in the navigation area.
- **General settings**
- **Maintenance**
- **Device information** -----▶
- ✔ The **Product type code** is displayed.

### 13.2.9 Reading out the manufacturing date of the device

To read out the manufacturing date of the device, do the following:

- Select the device in the navigation area.
- **General settings**
- **Maintenance**
- **Device information** -----▶
- ✔ The **Manufacture date** is displayed.

### 13.2.10 Reading out the version of the embedded eds file

To read out the version of the embedded eds file, do the following:

- Select the device in the navigation area.
- **General settings**
- **Maintenance**
- **Device information** -----▶
- ✔ The **eds version** is displayed.

The content of the eds file is described in the related supplement available at [www.burkert.com](http://www.burkert.com)

## 13.3 Restarting or resetting the device

### 13.3.1 Restarting the device

To restart the device, do the following:

- Select the device in the navigation area.
- **General settings**
- **Maintenance**
- **Reset device** ----->
- **Restart** -----> **Next**

✔ The device restarts.

### 13.3.2 Resetting the device to all its factory settings

To reset the device to all its factory settings, do the following:

- Select the device in the navigation area.
- **General settings**
- **Maintenance**
- **Reset device** ----->
- **Reset to factory settings** -----> **Next**

✔ The device is reset to all its factory settings.



## 14 SAW SENSOR - PARAMETER

### 14.1 Safety instructions



#### WARNING

Risk of injury due to non-conforming adjustment.

Non-conforming adjustment could lead to injuries and damage the device and its surroundings.

- ▶ The operators in charge of adjustment must have read and understood the contents of the Operating Instructions.
- ▶ In particular, observe the safety recommendations and intended use.
- ▶ The device/installation must only be adjusted by suitably trained staff.

### 14.2 User levels of the editable menu items

Menu item of the <b>SAW sensor - Parameter</b> menu	Minimum user level
<b>Stand. meas. values</b> (standard measurement values)	<b>Advanced user</b>
<b>Add. meas. values</b> (additional measurement values)	
<b>Diag. events</b> (diagnostics events)	
<b>Refresh time</b>	<b>Installer</b>

### 14.3 Default settings

You can find the default settings of the device in the CANopen supplement for the Type 8098 at [www.burkert.com](http://www.burkert.com)

→ Before making any changes to the settings, use the Bürkert Communicator software to print a pdf file with all the default settings of the device.

## 14.4 Setting the parameters of the volume flow rate

### 14.4.1 Giving a user defined name to the measured volume flow rate

The name is used to identify the process value in the user defined views and in all the menus where the process value is displayed.

By default, the name associated to the measured volume flow rate is **Volume flow**.

To add a user defined name to the default name, do the following:

- Select the device in the navigation area.
- **SAW sensor**
- **Parameter**
- **Stand. meas. values** ----->
- **Volume flow** ----->
- **Value name** ----->
- Enter the name. The name can have up to 19 characters.
- **Apply**
- ✓ The name is changed.

### 14.4.2 Activating the damping of the volume flow rate values and selecting a predefined damping level

The damping makes it possible to damp the fluctuations of the measured values of the volume flow rate:

- on the totalizers,
- on the outputs. The damping set for an analog output comes in addition to the damping of the volume flow. <sup>\*)</sup>
- on the liquid velocity value. The damping of the volume flow comes in addition to the damping set for the liquid velocity.

The damping is not applied to the new measured value, if the 2 following conditions are met:

- a **Low**, **Medium** or **High** damping level is active,
- and the variation between 2 values that are measured one after the other is higher than 30 % (for example when charging the pipe or stopping the flow).

By default, the measured volume flow rate values are damped with the level **Medium**.

The low damping level or no damping at all (**None**) are suited for applications/processes that need fast response times.

The medium damping level or the high damping level are suited if the flow rate values change slowly.

- As an alternative to the 3 predefined damping levels **Low**, **Medium** or **High**, you can set your own damping parameters. See chpt. [14.4.3](#).

---

<sup>\*)</sup> Only variant with outputs.

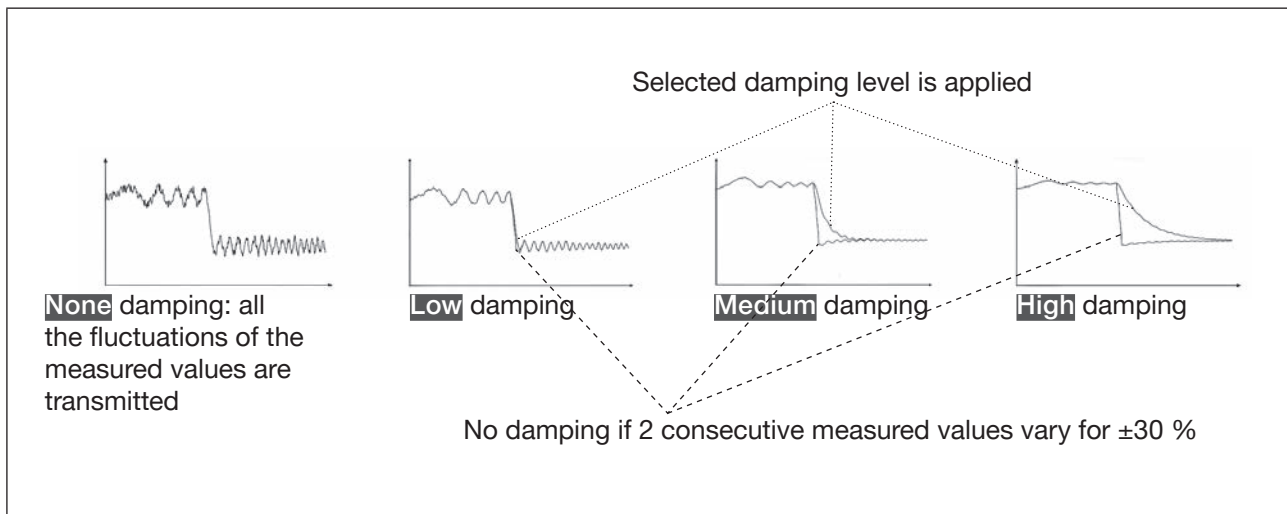

Figure 22: Operation of the available damping levels

Damping level (mode)	Response time
None	<ul style="list-style-type: none"> <li>• 5 s if the <b>Refresh time</b> is set to <b>Long</b></li> <li>• &lt; 0.5 s if the <b>Refresh time</b> is set to <b>Short</b> or <b>Very short</b></li> </ul>
Low	1 s
Medium	10 s
High	30 s
Special	User-defined <b>Response time</b> : see chpt. 14.4.3

Table 8: Response times (10%...90%) of the damping levels for the volume flow rate measurements

To set a predefined damping level of the measured volume flow rate values, do the following:

- Select the device in the navigation area.
- **SAW sensor**
- **Parameter**
- **Stand. meas. values** ----->
- **Volume flow** ----->
- **Damping** ----->

The current settings are displayed.

- Select a damping level (mode) between **Low**, **Medium** and **High**.

The new settings are displayed.

- **Finish**

✓ The damping of the volume flow rate values is active and a predefined damping level is selected.

### 14.4.3 Activating a user-defined damping of the volume flow rate values

The damping makes it possible to damp the fluctuations of the measured values of the volume flow rate:

- on the totalizers,
- on the outputs. The damping set for an analog output comes in addition to the damping of the volume flow. \*)
- on the liquid velocity value. The damping of the volume flow comes in addition to the damping set for the liquid velocity.

By default, the measured volume flow rate values are damped with the level **Medium**.

To damp the fluctuations of the measured values, you can:

- either choose 1 of the 3 predefined damping levels: **Low**, **Medium** or **High**. See chpt. 14.4.2.
- Or you can set your own damping parameters with the **Special** damping.

With the **Special** damping, you can set 2 parameters:

- a user-defined **Response time** in s,
- the **Jump threshold**, i.e. a user-defined percentage. If 2 consecutive measured values vary for  $\pm$  the percentage, no damping is applied to the second measured value.

To set your own damping parameters of the measured volume flow rate values, do the following:

- Select the device in the navigation area.
- **SAW sensor**
- **Parameter**
- **Stand. meas. values** ----->
- **Volume flow** ----->
- **Damping** ----->

The current settings are displayed.

- Select **Special** ----->
- Set the value of the **Response time** ----->
- Select if the **Jump threshold** is enabled or disabled ----->
- If the **Jump threshold** is enabled, set the value.

The new settings are displayed

- **Finish**

✔ The special damping of the volume flow rate values is active.

\*) Only variant with outputs.

#### 14.4.4 Deactivating the damping of the volume flow rate values

By default, the volume flow rate values are not damped.

But if the damping of the volume flow rate values is active, do the following to deactivate it:

→ Select the device in the navigation area.

→ **SAW sensor**

→ **Parameter**

→ **Stand. meas. values** ----->

→ **Volume flow** ----->

→ **Damping** ----->

The current settings are displayed.

→ Select **None** ----->

The new settings are displayed

→ **Finish**

The damping of the volume flow rate values is inactive.

#### 14.4.5 Activating the monitoring of the volume flow rate

Because of a malfunction in the process or in the flow rate sensor, the measured flow rate value can be too high or too low.

A monitored value can be:

- in the normal operating range
- in the warning range
- in the error range

You can set 4 limit values: 2 error limits and 2 warning limits.

→ To set the limit values, see [chpt. 14.4.7 Changing the error limits, the warning limits and the hysteresis of the volume flow rate.](#)

[Figure 23](#) explains how the device reacts when the monitored value enters in another range (for example, from the normal range into the warning range). The reaction time depends on the hysteresis value and whether the monitored value increases or decreases.

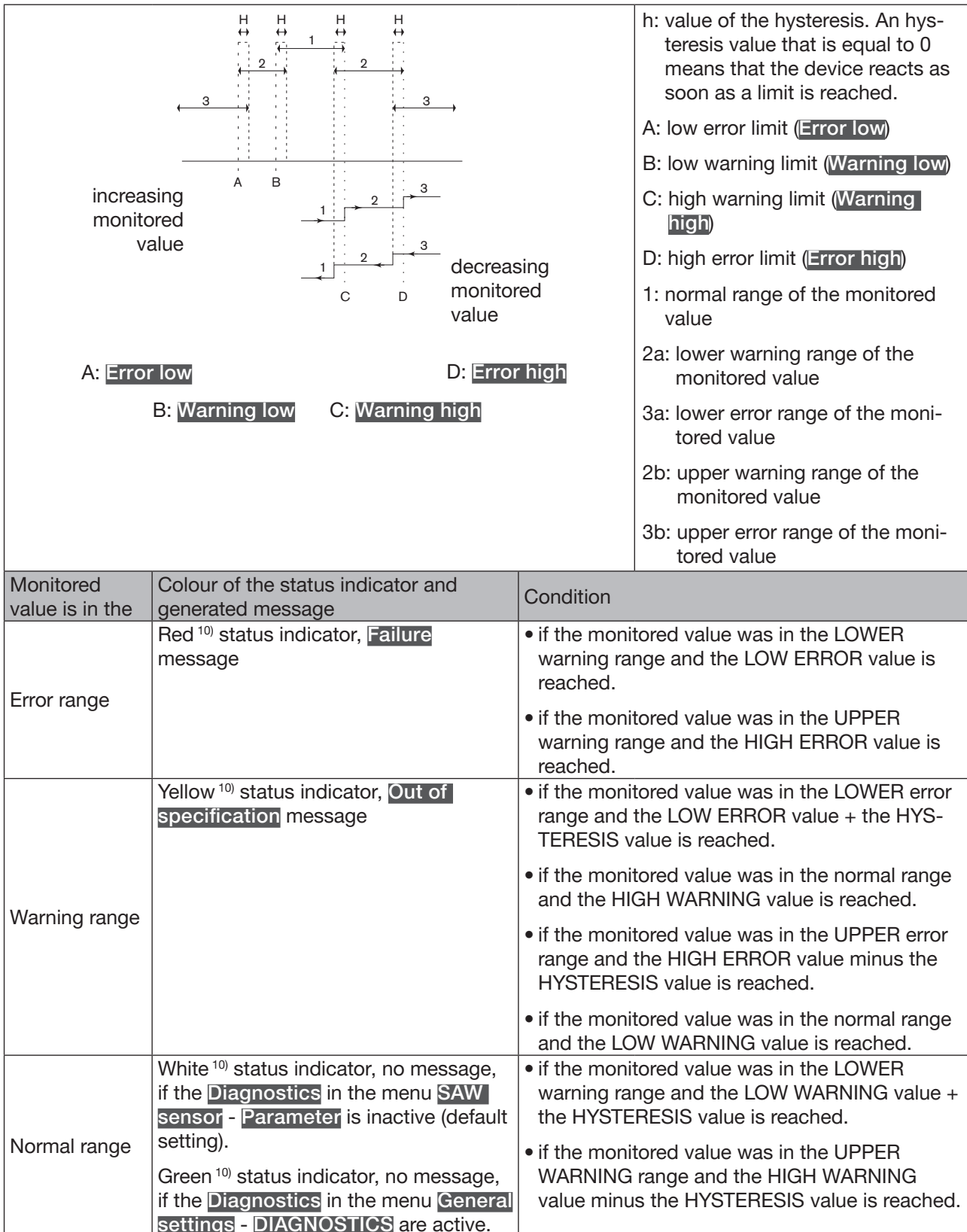

Figure 23: Operating principle of the monitoring with an hysteresis

By default, the monitoring of the volume flow rate is disabled, and the diagnostics are all disabled.

To activate the monitoring of the volume flow rate, do the following:

→ Select the device in the navigation area.

→ **SAW sensor**

→ **Parameter**

→ **Stand. meas. values** ----->

→ **Volume flow** ----->

→ **Limits** ----->

→ **Active** ----->

→ Select **Yes**.

The monitoring of the volume flow rate is active and the device status will change depending on the limits that have been set.

→ You can configure the behaviour of an analogue output depending on the status of the device. See chpt. [17.3.3 Configuring the behaviour of an analogue output depending on the status of the device.](#)<sup>\*)</sup>

→ You can configure a digital output to switch every time a specific event is generated. See chpt. [17.5.1 Configuring a digital output as an on/off output.](#)<sup>\*)</sup>

→ To enable the monitoring, i.e. to be informed when the value of the volume flow rate is outside the normal range, enable the diagnostics. See chpt. [11.9 Activating the diagnostics functions.](#)

---

<sup>\*)</sup> Only variant with outputs.

#### 14.4.6 Deactivating the monitoring of the volume flow rate

By default, the volume flow rate values are not monitored.

If the monitoring of the volume flow rate is active, do the following to deactivate it:

→ Select the device in the navigation area.

→ **SAW sensor**

→ **Parameter**

→ **Stand. meas. values** ----->

→ **Volume flow** ----->

→ **Limits** ----->

→ **Active** ----->

→ Select **No**.

The monitoring of the volume flow rate is inactive.

### 14.4.7 Changing the error limits, the warning limits and the hysteresis of the volume flow rate

To change the error limits, the warning limits and the hysteresis of the volume flow rate, do the following:

→ Select the device in the navigation area.

→ **SAW sensor**

→ **Parameter**

→ **Stand. meas. values** ----->

→ **Volume flow** ----->

→ **Limits** ----->

→ **Settings** ----->

The current settings are displayed.

→ Set the high error limit ----->

→ Set the low error limit ----->

→ Set the high warning limit ----->

→ Set the low warning limit ----->

→ Set the hysteresis value ----->

The new settings are displayed.

→ **Finish**

✓ The limit values and the hysteresis value are changed.



### 14.4.8 Resetting the default values of the error limits, the warning limits and the hysteresis of the volume flow rate

The default values of the error limits, the warning limits and the hysteresis of the volume flow rate depend on the DN of the measurement tube:

- high error value: maximum flow rate value authorized for the DN,
- low error value: opposite value of the high error value,
- high warning value: 80% of the maximum flow rate value authorized for the DN,
- low warning value: opposite value of the high warning value,
- value of the hysteresis: 0.0 l/min.

To reset the default values of the error limits, the warning limits and the hysteresis of the volume flow rate, do the following:

- Select the device in the navigation area.
- **SAW sensor**
- **Parameter**
- **Stand. meas. values** ----->
- **Volume flow** ----->
- **Limits** ----->
- **Reset to default** ----->
- **Finish**

✓ The limit values and the hysteresis value are reset.

### 14.4.9 Enabling the cut-off function

If the absolute (and possibly damped, see chap 14.4.2) measured flow rate is less than the cut-off value plus an hysteresis value, the flow rate value is set to 0:

The outputs\*) and the totalizers react as if the actual flow rate were equal to 0.

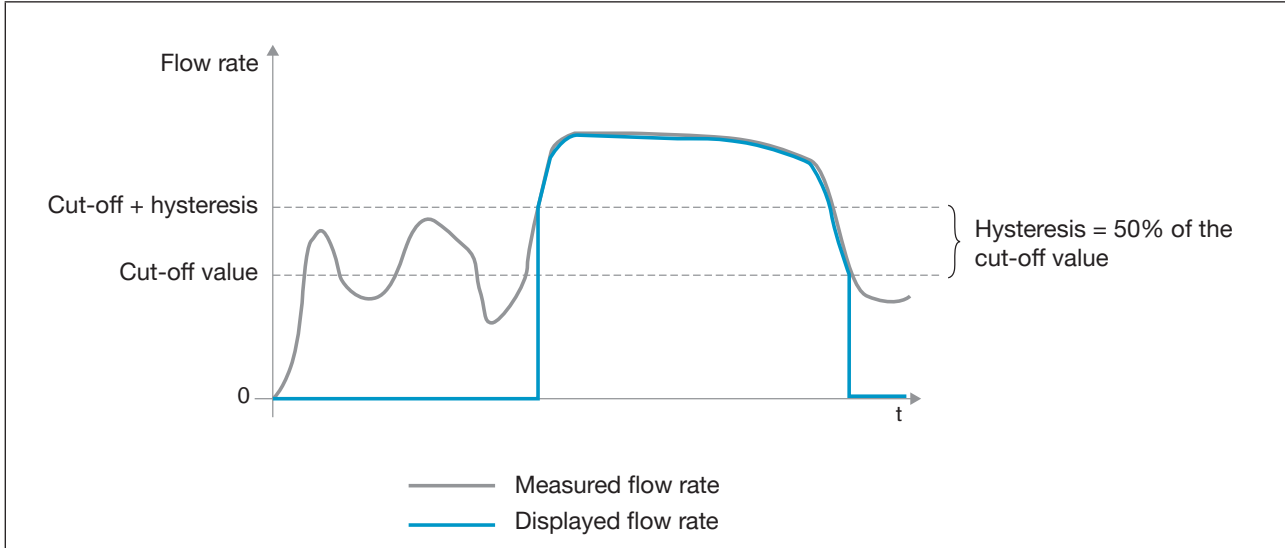

Figure 24: Operation of the cut-off function

By default, the cut-off function is enabled.

If the cut-off function is disabled, do the following to enable it:

- Select the device in the navigation area.
- **SAW sensor**
- **Parameter**
- **Stand. meas. values** ----->
- **Volume flow** ----->
- **Cut-off** ----->
- **Status** ----->
- **Enabled**

The cut-off function is enabled.

\*) Only variant with outputs.

### 14.4.10 Changing the cut-off value of the flow rate

The default value of the cut-off flow rate is equal to 0.4% of the full scale value. The full scale value depends on the DN of the measurement tube.

To change the cut-off value of the flow rate, do the following:

- Select the device in the navigation area.
- **SAW sensor**
- **Parameter**
- **Stand. meas. values** ----->
- **Volume flow** ----->
- **Cut-off** ----->
- **Value** ----->
- Set the cut-off value.
- **Finish**
- ✔ The cut-off value of the flow rate is changed.

### 14.4.11 Disabling the cut-off function

If the cut-off function is enabled, do the following to disable it:

- Select the device in the navigation area.
- **SAW sensor**
- **Parameter**
- **Stand. meas. values** ----->
- **Volume flow** ----->
- **Cut-off** ----->
- **Status** ----->
- Select **Disabled**
- ✔ The cut-off function is disabled.

## 14.4.12 Resetting the default values of all the volume flow rate parameters

To reset all the default values of the volume flow rate parameters, do the following:

→ Select the device in the navigation area.

→ **SAW sensor**

→ **Parameter**

→ **Stand. meas. values** ----->

→ **Volume flow** ----->

→ **Reset to default** ----->

→ **Finish**

✓ All the volume flow rate parameters are reset.

## 14.5 Setting the parameters of the liquid temperature

### 14.5.1 Giving a user defined name to the measured liquid temperature

The name is used to identify the process value in the user defined views and in all the menus where the process value is displayed.

By default, the name associated to the measured liquid temperature is **Temperature**.

To add a user defined name to the default name, do the following:

- Select the device in the navigation area.
- **SAW sensor**
- **Parameter**
- **Stand. meas. values** ----->
- **Temperature** ----->
- **Value name** ----->
- Enter the name. The name can have up to 19 characters.
- **Apply**
- ✔ The name is changed.

### 14.5.2 Activating the damping of the liquid temperature values and selecting a predefined damping level

The damping makes it possible to damp the fluctuations of the measured values of the liquid temperature:

On the outputs. The damping of the liquid temperature comes in addition to the damping set for each analog output (see chpt. [17.3.2 Selecting the damping level of the values transmitted on an analogue output](#)).\*)

The damping is not applied to the new measured value, if the 2 following conditions are met:

- a **Low**, **Medium** or **High** damping level is active,
- and the variation between 2 values that are measured one after the other is higher than 20 °C.

The refresh time, set in chap [14.12](#), has no effect on the damping of the measured values.

By default, the measured liquid temperature values are not damped.

- As an alternative to the 3 predefined damping levels **Low**, **Medium** or **High**, you can set your own damping parameters. See [14.5.3](#).

---

\*) Only variant with outputs.

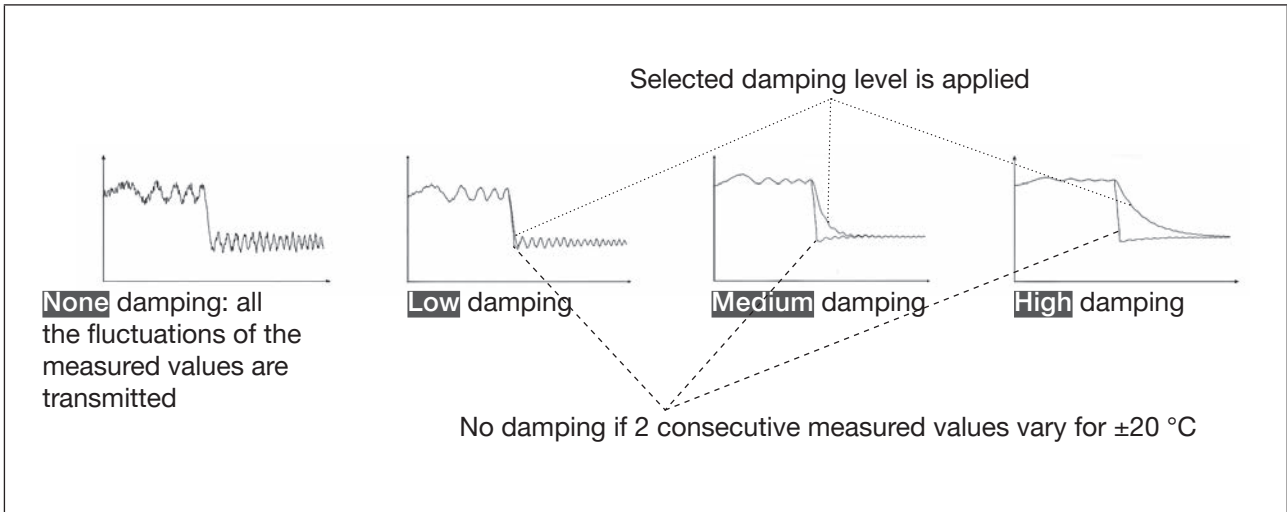

Figure 25: Operation of the available damping levels

Damping level	Response time
None	0 s
Low	1 s
Medium	10 s
High	30 s
Special	User-defined <b>Response time</b> : see chpt. 14.5.3

Table 9: Response times (10%...90%) of the damping levels for the liquid temperature measurements

To set a predefined damping level of the measured liquid temperature values, do the following:

- Select the device in the navigation area.
- **SAW sensor**
- **Parameter**
- **Stand. meas. values** ----->
- **Temperature** ----->
- **Damping** ----->

The current settings are displayed.

- Select a damping level between **Low**, **Medium** and **High**

The new settings are displayed.

- **Finish**

✔ The damping of the liquid temperature values is active and a predefined damping level is selected.

### 14.5.3 Activating a user-defined damping of the liquid temperature values

The damping makes it possible to damp the fluctuations of the measured values of the liquid temperature: on the outputs. The damping of the liquid temperature comes in addition to the damping set for each analog output (see chpt. [17.3.2 Selecting the damping level of the values transmitted on an analogue output](#)).\*)

By default, the measured liquid temperature values are not damped.

To damp the fluctuations of the measured values, you can:

- Either choose 1 of the 3 predefined damping levels: **Low**, **Medium** or **High**. See chpt. [14.5.2](#).
- Or you can set your own damping parameters with the **Special** damping.

With the **Special** damping, you can set 2 parameters:

- a user-defined **Response time** in seconds,
- the **Jump threshold**, i.e. a user-defined temperature value. If 2 consecutive measured values vary for  $\pm$  the set temperature value, no damping is applied to the second measured value.

To set your own damping parameters of the measured liquid temperature values, do the following:

- Select the device in the navigation area.
- **SAW sensor**
- **Parameter**
- **Stand. meas. values** ----->
- **Temperature** ----->
- **Damping** ----->

The current settings are displayed.

- Select **Special** ----->
- Set the value of the **Response time** ----->
- Select if the **Jump threshold** is enabled or disabled ----->
- If the **Jump threshold** is enabled, set the value.

The new settings are displayed.

- **Finish**
- ✓ The special damping of the liquid temperature values is active.

\*) Only variant with outputs.

## 14.5.4 Deactivating the damping of the liquid temperature values

By default, the liquid temperature values are not damped.

But if the damping of the liquid temperature values is active, do the following to deactivate it:

→ Select the device in the navigation area.

→ **SAW sensor**

→ **Parameter**

→ **Stand. meas. values** ----->

→ **Temperature** ----->

→ **Damping** ----->

The current settings are displayed.

→ Select **None** ----->

The new settings are displayed.

→ **Finish**

The damping of the liquid temperature values is inactive.



### 14.5.5 Activating the monitoring of the liquid temperature



If the temperature sensor is defective, the monitoring of the liquid temperature has no effect. In that case:

The message **No temperature sensor detected** is displayed.

Because of a malfunction in the process, the measured liquid temperature value can be too high or too low.

A monitored value can be:

- in the normal operating range
- in the warning range
- in the error range

You can set 4 limit values: 2 error limits and 2 warning limits.

→ To set the limit values, see chpt. [14.5.7 Changing the error limits, the warning limits and the hysteresis of the liquid temperature.](#)

Figure 23 in chpt. [14.4.5](#) explains how the device reacts when the monitored value enters in another range (for example, from the normal range into the warning range). The reaction time depends on the hysteresis value and if the monitored value increases or decreases.

By default, the monitoring of the liquid temperature and the diagnostics are all disabled.

To activate the monitoring of the liquid temperature, do the following:

→ Select the device in the navigation area.

→ **SAW sensor**

→ **Parameter**

→ **Stand. meas. values** ----->

→ **Temperature** ----->

→ **Limits** ----->

→ **Active** ----->

→ Select **Yes**.

✔ The monitoring of the liquid temperature is active and the device status will change depending on the limits that have been set.

→ You can configure the behaviour of an analogue output depending on the status of the device. See chpt. [17.3.3 Configuring the behaviour of an analogue output depending on the status of the device.](#)<sup>\*)</sup>

→ You can configure a digital output to switch every time a specific event is generated. See chpt. [17.5.1 Configuring a digital output as an on/off output.](#)<sup>\*)</sup>

→ To enable the monitoring, i.e. to be informed when the value of the liquid temperature is outside the normal range, enable the diagnostics. See chpt. [11.9 Activating the diagnostics functions.](#)

<sup>\*)</sup> Only variant with outputs.

### 14.5.6 Deactivating the monitoring of the liquid temperature

By default, the liquid temperature values are not monitored. If the monitoring of the liquid temperature is active, do the following to deactivate it:

- Select the device in the navigation area.
- **SAW sensor**
- **Parameter**
- **Stand. meas. values** ----->
- **Temperature** ----->
- **Limits** ----->
- **Active** ----->
- Select **No**
- ✓ The monitoring of the liquid temperature is inactive.

### 14.5.7 Changing the error limits, the warning limits and the hysteresis of the liquid temperature

To change the error limits, the warning limits and the hysteresis of the liquid temperature, do the following:

- Select the device in the navigation area.
- **SAW sensor**
- **Parameter**
- **Stand. meas. values** ----->
- **Temperature** ----->
- **Limits** ----->
- **Settings** ----->

The current settings are displayed.

- Set the high error limit ----->
- Set the low error limit ----->
- Set the high warning limit ----->
- Set the low warning limit ----->
- Set the hysteresis value ----->

The new settings are displayed.

- **Finish**
- ✓ The limit values and the hysteresis value are changed.

### 14.5.8 Resetting the default values of the error limits, the warning limits and the hysteresis of the liquid temperature

The default values of the error limits, the warning limits and the hysteresis of the liquid temperature are:

- high error value: 150.0 °C
- low error value: -20.0 °C
- high warning value: 140.0 °C
- low warning value: -10.0 °C
- value of the hysteresis: 0.0 °C

To reset the default values of the error limits, the warning limits and the hysteresis of the liquid temperature, do the following:

→ Select the device in the navigation area.

→ **SAW sensor**

→ **Parameter**

→ **Stand. meas. values** ----->

→ **Temperature** ----->

→ **Limits** ----->

→ **Reset to default** ----->

→ **Finish**

✓ The limit values and the hysteresis value are reset.

### 14.5.9 Resetting the default values of all the liquid temperature parameters

To reset all the default values of the liquid temperature parameters, do the following:

→ Select the device in the navigation area.

→ **SAW sensor**

→ **Parameter**

→ **Stand. meas. values** ----->

→ **Temperature** ----->

→ **Reset to default** ----->

→ **Finish**

✓ All the liquid temperature parameters are reset.

## 14.6 Setting the parameters of the liquid velocity

### 14.6.1 Giving a user defined name to the measured liquid velocity

The name is used to identify the process value in the user defined views and in all the menus where the process value is displayed (for example in the **Outputs** menu).

By default, the name associated to the measured liquid velocity is **Liquid velocity**.

To add a user defined name to the default name, do the following:

- Select the device in the navigation area.
- **SAW sensor**
- **Parameter**
- **Stand. meas. values** ----->
- **Liquid velocity** ----->
- **Value name** ----->
- Enter the name. The name can have up to 19 characters.
- **Apply**
- The name is changed.

### 14.6.2 Activating the damping of the liquid velocity values and selecting a predefined damping level

The damping of the liquid velocity comes in addition to the damping set for the volume flow. The damping makes it possible to damp the fluctuations of the measured values of the liquid velocity:

On the outputs. The damping of the liquid velocity comes in addition to the damping set for each analog output (see chpt. [17.3.2 Selecting the damping level of the values transmitted on an analogue output](#).\*)

The damping is not applied to the new measured value, if the 2 following conditions are met:

- a **Low**, **Medium** or **High** damping level is active
- and the variation between 2 values that are measured one after the other is higher than 30 % (for example when charging the pipe or stopping the flow)

By default, the liquid velocity values are not damped.

- As an alternative to the 3 predefined damping levels **Low**, **Medium** or **High**, you can set your own damping parameters. See [14.6.3](#).

---

\**Only variant with outputs.*

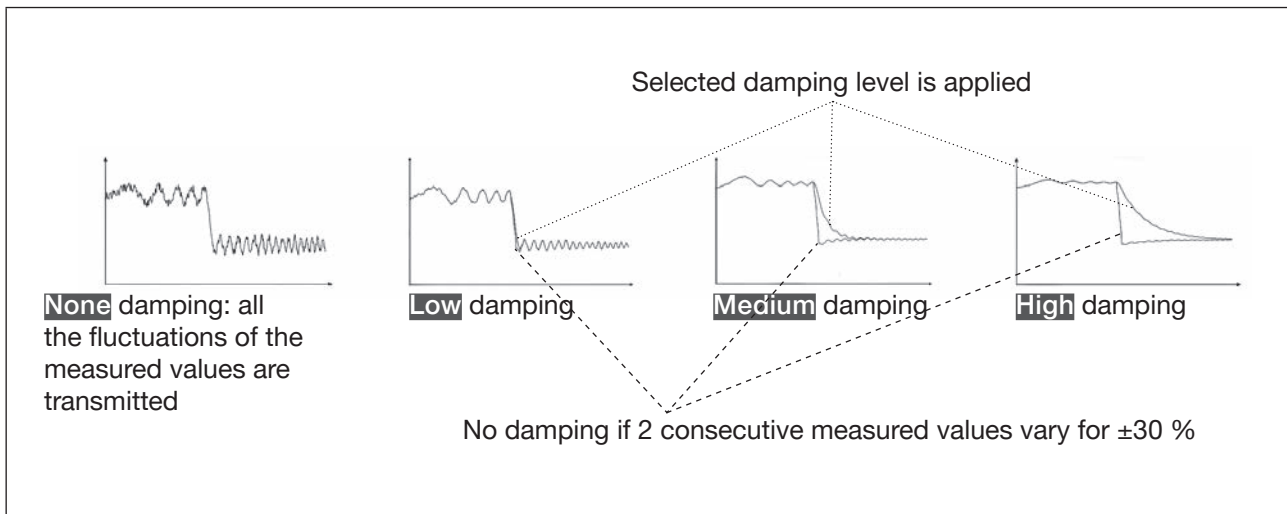

Figure 26: Operation of the available damping levels

Damping level	Response time which is associated with the damping level chosen for the volume flow plus...
None	<ul style="list-style-type: none"> <li>• 5 s if the <b>Refresh time</b> is set to <b>Long</b></li> <li>• &lt; 0.5 s if the <b>Refresh time</b> is set to <b>Short</b> or <b>Very short</b>.</li> </ul>
Low	-1 s
Medium	-10 s
High	-30 s
Special	...User-defined <b>Response time</b> ; see chpt. 14.6.3

Table 10: Response times (10%...90%) of the damping levels for the liquid velocity measurements

To set a predefined damping level of the measured liquid velocity values, do the following:

- Select the device in the navigation area.
- **SAW sensor**
- **Parameter**
- **Stand. meas. values** ----->
- **Liquid velocity** ----->
- **Damping** ----->

The current settings are displayed.

- Select a damping level between **Low**, **Medium** and **High** ----->

The new settings are displayed.

- **Finish**

✔ The damping of the liquid velocity values is active and a predefined damping level is selected.

### 14.6.3 Activating a user-defined damping of the liquid velocity values

The damping makes it possible to damp the fluctuations of the measured values of the liquid velocity: On the outputs. The damping of the liquid velocity comes in addition to the damping set for each analog output (see chpt. [17.3.2 Selecting the damping level of the values transmitted on an analogue output](#).)<sup>\*)</sup>

By default, the measured liquid velocity values are not damped.

To damp the fluctuations of the measured values, you can:

- Either choose 1 of the 3 predefined damping levels: **Low**, **Medium** or **High**. See chpt. [14.6.2](#).
- Or you can set your own damping parameters with the **Special** damping.

With the **Special** damping, you can set 2 parameters:

- a user-defined **Response time** in seconds,
- the **Jump threshold**, i.e. a user-defined percentage. If 2 consecutive measured values vary for  $\pm$  the percentage, no damping is applied to the second measured value.

To set your own damping parameters of the measured liquid velocity values, do the following:

- Select the device in the navigation area.
- **SAW sensor**
- **Parameter**
- **Stand. meas. values** ----->
- **Liquid velocity** ----->
- **Damping** ----->

The current settings are displayed.

- Select **Special** ----->
- Set the value of the **Response time** ----->
- Select if the **Jump threshold** is enabled or disabled ----->
- If the **Jump threshold** is enabled, set the value. ----->

The new settings are displayed.

- **Finish**
- The special damping of the liquid velocity values is active.

<sup>\*)</sup> Only variant with outputs.

#### 14.6.4 Deactivating the damping of the liquid velocity values

By default, the liquid velocity values are not damped.

But if the damping of the liquid velocity values is active, do the following to deactivate it:

→ Select the device in the navigation area.

→ **SAW sensor**

→ **Parameter**

→ **Stand. meas. values** ----->

→ **Liquid velocity** ----->

→ **Damping** ----->

The current settings are displayed.

→ Select **None** ----->

The new settings are displayed.

→ **Finish**

The damping of the liquid velocity values is inactive.

#### 14.6.5 Activating the monitoring of the liquid velocity

Because of a malfunction in the process or in the flow rate sensor, the measured liquid velocity value can be too high or too low.

A monitored value can be:

- in the normal operating range
- in the warning range
- in the error range

You can set 4 limit values: 2 error limits and 2 warning limits.

→ To set the limit values, see [chpt. 14.6.7 Changing the error limits, the warning limits and the hysteresis of the liquid velocity.](#)

[Figure 23](#) in [14.4.5](#) explains how the device reacts when the monitored value enters in another range (for example, from the normal range into the warning range). The reaction time depends on the hysteresis value and if the monitored value increases or decreases.

By default, the monitoring of the liquid velocity and the diagnostics are all disabled.

To activate the monitoring of the liquid velocity, do the following:

- Select the device in the navigation area.
- **SAW sensor**
- **Parameter**
- **Stand. meas. values** ----->
- **Liquid velocity** ----->
- **Limits** ----->
- **Active** ----->
- Select **Yes**.

- The monitoring of the liquid velocity is active and the device status will change depending on the limits that have been set.
- You can configure the behaviour of an analogue output depending on the status of the device. See chpt. [17.3.3 Configuring the behaviour of an analogue output depending on the status of the device.](#)\*)
- You can configure a digital output to switch every time a specific event is generated. See chpt. [17.5.1 Configuring a digital output as an on/off output.](#)\*)
- To enable the monitoring, i.e. to be informed when the value of the liquid velocity is outside the normal range, enable the diagnostics. See chpt. [11.9 Activating the diagnostics functions](#).

---

\*) Only variant with outputs.

### 14.6.6 Deactivating the monitoring of the liquid velocity

By default, the liquid velocity values are not monitored.

If the monitoring of the liquid velocity is active, do the following to deactivate it:

- Select the device in the navigation area.
- **SAW sensor**
- **Parameter**
- **Stand. meas. values** ----->
- **Liquid velocity** ----->
- **Limits** ----->
- **Active** ----->
- Select **No**.

- The monitoring of the liquid velocity is inactive.



### 14.6.7 Changing the error limits, the warning limits and the hysteresis of the liquid velocity

To change the error limits, the warning limits and the hysteresis of the liquid velocity, do the following:

- Select the device in the navigation area.
- **SAW sensor**
- **Parameter**
- **Stand. meas. values** ----->
- **Liquid velocity** ----->
- **Limits** ----->
- **Settings** ----->

The current settings are displayed.

- Set the high error limit ----->
- Set the low error limit ----->
- Set the high warning limit ----->
- Set the low warning limit ----->
- Set the hysteresis value ----->

The new settings are displayed.

- **Finish**

The limit values and the hysteresis value are changed.

### 14.6.8 Resetting the default values of the error limits, the warning limits and the hysteresis of the liquid velocity

The default values of the error limits, the warning limits and the hysteresis of the liquid velocity are the following:

- high error value: +10.0 m/s
- low error value: -10.0 m/s
- high warning value: +8.0 m/s
- low warning value: -8.0 m/s
- value of the hysteresis: 0.0 m/s

To reset the default values of the error limits, the warning limits and the hysteresis of the liquid velocity, do the following:

- Select the device in the navigation area.
- **SAW sensor**
- **Parameter**
- **Stand. meas. values** ----->
- **Liquid velocity** ----->
- **Limits** ----->
- **Reset to default** ----->
- **Finish**

✔ The limit values and the hysteresis value are reset.

### 14.6.9 Resetting the default values of all the liquid velocity parameters

To reset all the default values of all the liquid velocity parameters, do the following:

- Select the device in the navigation area.
- **SAW sensor**
- **Parameter**
- **Stand. meas. values** ----->
- **Liquid velocity** ----->
- **Reset to default** ----->
- **Finish**

✔ All the liquid velocity parameters are reset.

## 14.7 Setting the parameters of the totalizers

### 14.7.1 Giving a user defined name to each totalizer

The name is used to identify the process value in the user defined views and in all the menus where the process value is displayed.

By default, the names associated to the totalizers are **Totalizer 1** and **Totalizer 2**.

To add a user defined name to the default name of a totalizer, do the following:

- Select the device in the navigation area.
- **SAW sensor**
- **Parameter**
- **Stand. meas. values** ----->
- **Totalizer 1** or **Totalizer 2** ----->
- **Value name** ----->
- Enter the name. The name can have up to 19 characters.
- **Apply**
- ✔ The name is changed.

### 14.7.2 Selecting the counting direction of each totalizer

By default, the counting direction of both totalizers is **Positive only**.

The possible counting directions are:

- **Positive only**: the totalizer counts the volume of liquid that flows in the direction defined as positive, i.e. in the same direction as the arrow located on the front of the device.
- **Negative only**: the totalizer counts the volume of liquid that flows in the direction defined as negative, i.e. in the direction opposite to the direction of the arrow located on the front of the device.
- **Both**: the totalizer counts the volume of liquid that flows in the direction defined as positive but deducts the volume of liquid that flows in the direction defined as negative.

To change the counting direction of each totalizer, do the following:

- Select the device in the navigation area.
- **SAW sensor**
- **Parameter**
- **Stand. meas. values** ----->
- **Totalizer 1** or **Totalizer 2** ----->
- **Counting direction** ----->
- Select a counting direction.
- ✔ The counting direction is changed.

### 14.7.3 Activating the monitoring of each totalizer value

A monitored value can be:

- in the normal operating range
- in the warning range
- in the error range

You can set 4 limit values: 2 error limits and 2 warning limits.

→ To set the limit values, see chpt. [14.7.5 Changing the error limits, the warning limits and the hysteresis of each totalizer.](#)

Figure 23 in [14.4.5](#) explains how the device reacts when the monitored value enters in another range (for example, from the normal range into the warning range). The reaction time depends on the hysteresis value and if the monitored value increases or decreases.

By default, the monitoring of the totalizers and the diagnostics are all disabled.

To activate the monitoring of each totalizer, do the following:

→ Select the device in the navigation area.

→ **SAW sensor**

→ **Parameter**

→ **Stand. meas. values** ----->

→ **Totalizer 1** or **Totalizer 2** ----->

→ **Limits** ----->

→ **Active** ----->

→ Select **Yes**

The monitoring of the totalizer is active and the device status will change depending on the limits that have been set.

→ You can configure the behaviour of an analogue output depending on the status of the device. See chpt. [17.3.3 Configuring the behaviour of an analogue output depending on the status of the device.](#)\*)

→ You can configure a digital output to switch every time a specific event is generated. See chpt. [17.5.1 Configuring a digital output as an on/off output.](#)\*)

→ To enable the monitoring, i.e. to be informed when the value of a totalizer is outside the normal range, enable the diagnostics. See chpt. [11.9 Activating the diagnostics functions.](#)

---

\*) *Only variant with outputs.*

#### 14.7.4 Deactivating the monitoring of each totalizer

By default, the totalizers are not monitored.

If the monitoring of a totalizer is active, do the following to deactivate it:

→ Select the device in the navigation area.

→ **SAW sensor**

→ **Parameter**

→ **Stand. meas. values** -----▶

→ **Totalizer 1** or **Totalizer 2** -----▶

→ **Limits** -----▶

→ **Active** -----▶

→ Select **No.**

The monitoring of the totalizer is inactive.

#### 14.7.5 Changing the error limits, the warning limits and the hysteresis of each totalizer

To change the error limits, the warning limits and the hysteresis of each totalizer, do the following:

→ Select the device in the navigation area.

→ **SAW sensor**

→ **Parameter**

→ **Stand. meas. values** -----▶

→ **Totalizer 1** or **Totalizer 2** -----▶

→ **Limits** -----▶

→ **Settings** -----▶

The current settings are displayed.

→ Set the high error limit -----▶

→ Set the low error limit -----▶

→ Set the high warning limit -----▶

→ Set the low warning limit -----▶

→ Set the hysteresis value -----▶

The new settings are displayed.

→ **Finish**

The limit values and the hysteresis value are changed.

### 14.7.6 Resetting the default values of the error limits, the warning limits and the hysteresis of each totalizer

The default values of the error limits, the warning limits and the hysteresis of the totalizers are the following:

- high error value: 10,000,000 m<sup>3</sup>
- low error value: -10,000,000 m<sup>3</sup>
- high warning value: 8,000,000 m<sup>3</sup>
- low warning value: -8,000,000 m<sup>3</sup>
- value of the hysteresis: 0.0 m<sup>3</sup>

To reset the default values of the error limits, the warning limits and the hysteresis of each totalizer, do the following:

→ Select the device in the navigation area.

→ **SAW sensor**

→ **Parameter**

→ **Stand. meas. values** ----->

→ **Totalizer 1** or **Totalizer 2** ----->

→ **Limits** ----->

→ **Reset to default** ----->

→ **Finish**

✓ The limit values and the hysteresis value are reset.

### 14.7.7 Enabling the user to start, stop or reset each totalizer

By default, the user is not allowed to start, to stop or to reset a totalizer.

To authorize the user to start, to stop or to reset a totalizer, do the following:

→ Select the device in the navigation area.

→ **SAW sensor**

→ **Parameter**

→ **Stand. meas. values** ----->

→ **Totalizer 1** or **Totalizer 2** ----->

→ **Start/Stop/Reset** ----->

→ Select **Enabled**

✓ The user is authorized to start, to stop or to reset a totalizer.

### 14.7.8 Disabling the user to start, stop or reset each totalizer

By default, the user is not allowed to start, to stop or to reset a totalizer.

If the **Start/Stop/Reset** of a totalizer is active, do the following to disable them:

→ Select the device in the navigation area.

→ **SAW sensor**

→ **Parameter**

→ **Stand. meas. values** ----->

→ **Totalizer 1** or **Totalizer 2** ----->

→ **Start/Stop/Reset** ----->

→ Select **Disabled**

The user is not authorized to start or to stop or to reset a totalizer.

### 14.7.9 Starting a totalizer

If the **Start/Stop/Reset** of a totalizer is active, do the following to start the totalizer:

→ Select the device in the navigation area.

→ **SAW sensor**

→ **Parameter**

→ **Stand. meas. values** ----->

→ **Totalizer 1** or **Totalizer 2** ----->

→ **Start/Stop** ----->

→ Select **Started**

The totalizer starts to count.

### 14.7.10 Stopping a totalizer

If the **Start/Stop/Reset** of a totalizer is active, do the following to stop the totalizer:

→ Select the device in the navigation area.

→ **SAW sensor**

→ **Parameter**

→ **Stand. meas. values** ----->

→ **Totalizer 1** or **Totalizer 2** ----->

→ **Start/Stop** ----->

→ Select **Stopped**

The totalizer stops counting.

### 14.7.11 Resetting each totalizer to a **Preset value**

If the **Start/Stop/Reset** of a totalizer is active, do the following to reset the totalizer to the **Preset value**:

- Select the device in the navigation area.
- **SAW sensor**
- **Parameter**
- **Stand. meas. values** ----->
- **Totalizer 1** or **Totalizer 2** ----->
- **Value reset** ----->
- **Finish**

✔ The totalizer is reset to the preset value.

→ To change the preset value of a totalizer, see [chpt. 14.7.12 Changing the Preset value for a totalizer reset](#).

### 14.7.12 Changing the **Preset value** for a totalizer reset

The default value of the **Preset value** is 0 ml.

If the **Start/Stop/Reset** of a totalizer is active, do the following to change the preset value:

- Select the device in the navigation area.
- **SAW sensor**
- **Parameter**
- **Stand. meas. values** ----->
- **Totalizer 1** or **Totalizer 2** ----->
- **Preset value** ----->
- Set the value.
- **Apply**

✔ The value is changed.



### 14.7.13 Resetting the overflow counter of a totalizer

If a totalizer reaches its maximum value, the associated overflow counter value is incremented by 1.

To reset the overflow counter associated to each totalizer, do the following:

→ Select the device in the navigation area.

→ **SAW sensor**

→ **Parameter**

→ **Stand. meas. values** ----->

→ **Totalizer 1** or **Totalizer 2** ----->

→ **Reset overflow counter** ----->

→ **Finish**

✔ The overflow counter associated to the totalizer is reset.

### 14.7.14 Resetting all the parameters of a totalizer to the default values

To reset all the parameters of a totalizer to the default values, do the following:

→ Select the device in the navigation area.

→ **SAW sensor**

→ **Parameter**

→ **Stand. meas. values** ----->

→ **Totalizer 1** or **Totalizer 2** ----->

→ **Reset to default** ----->

→ **Finish**

✔ All the parameters of each totalizer are reset to their default values.

## 14.8 Setting the parameters of the density factor (optional feature)

### 14.8.1 What is the density factor?

The density factor is a dimensionless measurement value which can be used to identify the liquid flowing through the pipe.

The density factor is a non-calibrated acoustic measurement based on the measurement of the speed of sound in the liquid and can be compensated by temperature. The density factor gives an idea of the the density of most of aqueous liquids. By default, the temperature compensation is related to water.

→ To set a temperature compensation, refer to chpt. [14.8.10](#).

Air bubbles in the liquid have an unwanted effect on the density factor accuracy.

The device measures density factors in the range of 0.8 – 1.3:

- If a liquid flowing through the pipe has a higher density than water, the measured density factor is higher than 1.
- If a liquid flowing through the pipe has a lower density than water, the measured density factor is lower than 1.

Examples of density factor ranges:

- The density factor of water is in the range of 0.95 – 1.05.
- The density factor of tomato ketchup is in the range of 1.1 – 1.3.

### 14.8.2 Giving a user defined name to the measured density factor

The name is used to identify the process value in the user defined views and in all the menus where the process value is displayed (for example in the **Outputs** menu).

By default, the name associated to the measured density factor is **Density factor**.

To add a user defined name to the default name, do the following:

→ Select the device in the navigation area.

→ **SAW sensor**

→ **Parameter**

→ **Add. meas. values** ----->

→ **Density factor** ----->

→ **Value name** ----->

→ Enter the name. The name can have up to 19 characters.

→ **Apply**

✓ The name is changed.

### 14.8.3 Activating the damping of the density factor values and selecting a predefined damping level

The damping makes it possible to damp the fluctuations of the measured values of the density factor:

- On the totalizers
- On the outputs. The damping set for an analog output comes in addition to the damping of the density factor. \*)

The damping is not applied to the new measured value, if the 2 following conditions are met:

- a **Low**, **Medium** or **High** damping level is active
- and the variation between 2 values that are measured one after the other is higher than 30 % (for example when changing the fluid in the pipe)

By default, the density factor values are not damped.

The **Low** damping level or no damping at all (**None**) are suited for applications or processes that need fast response times.

The **Medium** damping level or the **High** damping level are suited if the density factor values change slowly.

→ As an alternative to the 3 predefined damping levels **Low**, **Medium** or **High**, you can set your own damping parameters. See [14.8.4](#)

\*) Only variant with outputs.

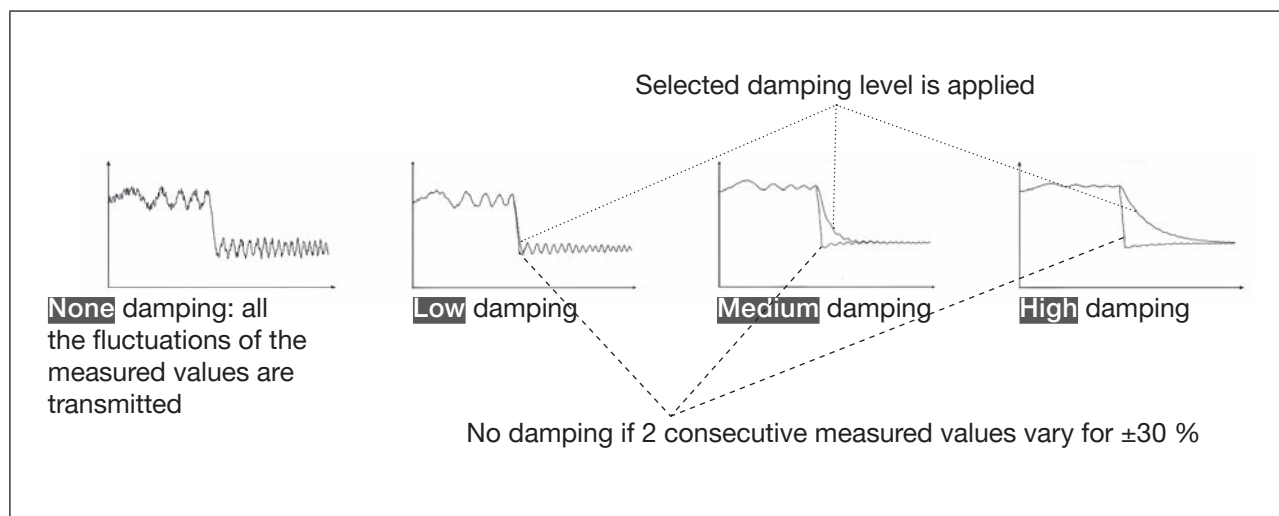

Figure 27: Operation of the available damping levels

Damping level	Response time
None	0 s
Low	1 s
Medium	10 s
High	30 s
Special	...User-defined <b>Response time</b> : see chapter

Table 11: Response times (10%...90%) of the damping levels for the density factor measurements

To set a predefined damping level of the density factor, do the following:

- Select the device in the navigation area.
- **SAW sensor**
- **Parameter**
- **Add. meas. values** ----->
- **Density factor** ----->
- **Damping** ----->

The current settings are displayed.

- Select a damping level between **Low**, **Medium** and **High** ----->

The new settings are displayed.

- **Finish**

✓ The damping of the liquid velocity values is active and a predefined damping level is selected.

#### 14.8.4 Activating a user-defined damping of the density factor values

The damping makes it possible to damp the fluctuations of the measured values of the density factor:

- On the totalizers
- On the outputs. The damping of the density factor comes in addition to the damping set for each analog output\*)

By default, the measured density factor values are not damped.

To damp the fluctuations of the measured values, you can:

- Either select 1 of the 3 predefined damping levels: **Low**, **Medium** or **High**. See chpt. .
- Or you can set your own damping parameters with the **Special** damping.

With the **Special** damping, you can set 2 parameters:

- a user-defined **Response time** in seconds,
- the **Jump threshold**, i.e. a user-defined percentage. If 2 consecutive measured values vary for ± the percentage, no damping is applied to the second measured value.

---

\*) Only variant with outputs.

To set your own damping parameters of the measured density factor values, do the following:

→ Select the device in the navigation area.

→ **SAW sensor**

→ **Parameter**

→ **Add. meas. values** -----▶

→ **Density factor** -----▶

→ **Damping** -----▶

The current settings are displayed.

→ Select **Special** -----▶

→ Set the value of the **Response time** -----▶

→ Select if the **Jump threshold** is enabled or disabled -----▶

→ If the **Jump threshold** is enabled, set the value. -----▶

The new settings are displayed.

→ **Finish**

✔ The special damping of the density factor values is active.

### 14.8.5 Deactivating the damping of the density factor values

By default, the density factor values are not damped.

If the damping of the density factor values is active, do the following to deactivate it:

→ Select the device in the navigation area.

→ **SAW sensor**

→ **Parameter**

→ **Add. meas. values** -----▶

→ **Density factor** -----▶

→ **Damping** -----▶

The current settings are displayed.

→ Select **None** -----▶

The new settings are displayed.

→ **Finish**

✔ The damping of the density factor values is inactive.

### 14.8.6 Activating the monitoring of the density factor

→ Before activating the monitoring of the density factor, set the density factor error and warning limits. See chpt. [14.8.8](#).

By default, the monitoring of the density factor and the diagnostics are all disabled.

To activate the monitoring of the density factor, do the following:

→ Select the device in the navigation area.

→ **SAW sensor**

→ **Parameter**

→ **Add. meas. values** ----->

→ **Density factor** ----->

→ **Limits** ----->

→ **Active** ----->

→ Select **Yes**.

The monitoring of the density factor is active and the device status will change depending on the limits that have been set.

→ You can transmit the density factor value with an analogue output to a PLC for example to identify the liquid flowing through the pipe. \*)

→ You can configure the behaviour of an analogue output depending on the status of the device. See chpt. [17.3.3 Configuring the behaviour of an analogue output depending on the status of the device.](#) \*)

→ You can configure a digital output to switch every time a specific event is generated. See chpt. [17.5.1 Configuring a digital output as an on/off output.](#) \*)

→ To enable the monitoring, i.e. to be informed when the value of the density factor is outside the normal range, enable the diagnostics. See chpt. [11.9 Activating the diagnostics functions](#).

---

\*) *Only variant with outputs.*

### 14.8.7 Deactivating the monitoring of the density factor

By default, the density factor values are not monitored. If the monitoring of the density factor is active, do the following to deactivate it:

→ Select the device in the navigation area.

→ **SAW sensor**

→ **Parameter**

→ **Add. meas. values** ----->

→ **Density factor** ----->

→ **Limits** ----->

→ **Active** ----->

→ Select **No**.

The monitoring of the density factor is inactive.

### 14.8.8 Changing the error limits, the warning limits and the hysteresis of the density factor

A monitored value can be:

- in the normal operating range
- in the warning range
- in the error range

You can set 4 limit values: 2 error limits and 2 warning limits.

→ To set the limit values, see chpt. [14.8.8 Changing the error limits, the warning limits and the hysteresis of the density factor](#).

Figure 23 in [14.4.5](#) explains how the device reacts when the monitored value enters in another range (for example, from the normal range into the warning range). The reaction time depends on the hysteresis value and if the monitored value increases or decreases.

By default, the monitoring of the density factor and the diagnostics are all disabled.

To change the error limits, the warning limits and the hysteresis of the density factor, do the following:

→ Select the device in the navigation area.

→ **SAW sensor**

→ **Parameter**

→ **Add. meas. values** ----->

→ **Density factor** ----->

→ **Limits** ----->

→ **Settings** ----->

The current settings are displayed.

→ Set the high error limit ----->

→ Set the low error limit ----->

→ Set the high warning limit ----->

→ Set the low warning limit ----->

→ Set the hysteresis value ----->

The new settings are displayed.

→ **Finish**

✓ The limit values and the hysteresis value are changed.

### 14.8.9 Resetting the default values of the error limits, the warning limits and the hysteresis of the density factor

The default values of the error limits, the warning limits and the hysteresis of the density factor are the following:

- high error value: 1.6000
- low error value: 0.5000
- high warning value: 1.5000
- low warning value: 0.6000
- value of the hysteresis: 0.0100

To reset the default values of the error limits, the warning limits and the hysteresis of the density factor, do the following:

→ Select the device in the navigation area.

→ **SAW sensor**

→ **Parameter**

→ **Add. meas. values** ----->

→ **Density factor** ----->

→ **Limits** ----->

→ **Reset to default** ----->

→ **Finish**

✓ The limit values and the hysteresis value are reset.

### 14.8.10 Setting the temperature compensation to measure the density factor

In order that the density factor of the liquid stays constant whatever the liquid temperature, the density factor must be temperature compensated.

You can only set the temperature compensation for 1 of the liquids that may flow through the pipe.

The device has 2 types of temperature compensations to measure the density factor:

- according to an equation that is specific to water, i.e. when water flows through the pipe, the density factor will always be equal to 1, whatever the water temperature. The equation for water cannot be changed. See chpt. [14.8.12 Activating the temperature compensation for water](#).
- according to an equation of 5th order for which you can set the 5 constants. See chpt. [14.8.11 Setting the temperature compensation for a liquid other than water](#).

By default, the temperature compensation is made according to an equation that is specific to water and that cannot be changed.



### 14.8.11 Setting the temperature compensation for a liquid other than water

You can set the 5 constants ( $a_0 \dots a_5$ ) of the equation which compensates the temperature of the liquid to calculate the density factor:

$$a_0 + a_1 T + a_2 T^2 + a_3 T^3 + a_4 T^4 + a_5 T^5$$

→ To help you define the 5 constants  $a_0$  to  $a_5$ , contact Bürkert.

To activate the temperature compensation for a liquid other than water, do the following:

→ Select the device in the navigation area.

→ **SAW sensor**

→ **Parameter**

→ **Add. meas. values** -----▶

→ **Density factor** -----▶

→ **Density factor compensation** -----▶

→ **Density factor compensation** -----▶

The current settings are displayed.

→ Select **Manual** -----▶

→ Set the value of the constant  $a_0$ , in the scientific notation. For example, to set the value 0,93724, enter 93.724000E-02 or, to set the value 372,4, enter 3.724000E+02.

→ Set the value of the constant  $a_1$ , in the scientific notation.

→ Set the value of the constant  $a_2$ , in the scientific notation.

→ Set the value of the constant  $a_3$ , in the scientific notation.

→ Set the value of the constant  $a_4$ , in the scientific notation.

→ Set the value of the constant  $a_5$ , in the scientific notation.

The new settings are displayed.

→ **Finish**

✔ The temperature compensation for a liquid other than water is active.

### 14.8.12 Activating the temperature compensation for water

To activate the temperature compensation for water, do the following:

- Select the device in the navigation area.
- **SAW sensor**
- **Parameter**
- **Add. meas. values** ----->
- **Density factor** ----->
- **Density factor compensation** ----->
- **Density factor compensation** ----->

The current settings are displayed.

- Select **Water** ----->

The new settings are displayed.

- **Finish**

✔ The temperature compensation for water is active.

### 14.8.13 Resetting the default values of all the density factor parameters

To reset all the default values of the density factor parameters, do the following:

- Select the device in the navigation area.
- **SAW sensor**
- **Parameter**
- **Add. meas. values** ----->
- **Density factor** ----->
- **Reset to default** ----->
- **Finish**

✔ All the density factor parameters are reset.

### 14.8.14 Use case example of the density factor

If different liquids with different density factors may flow through the pipe, you can identify the liquid flowing through the pipe at a given time.

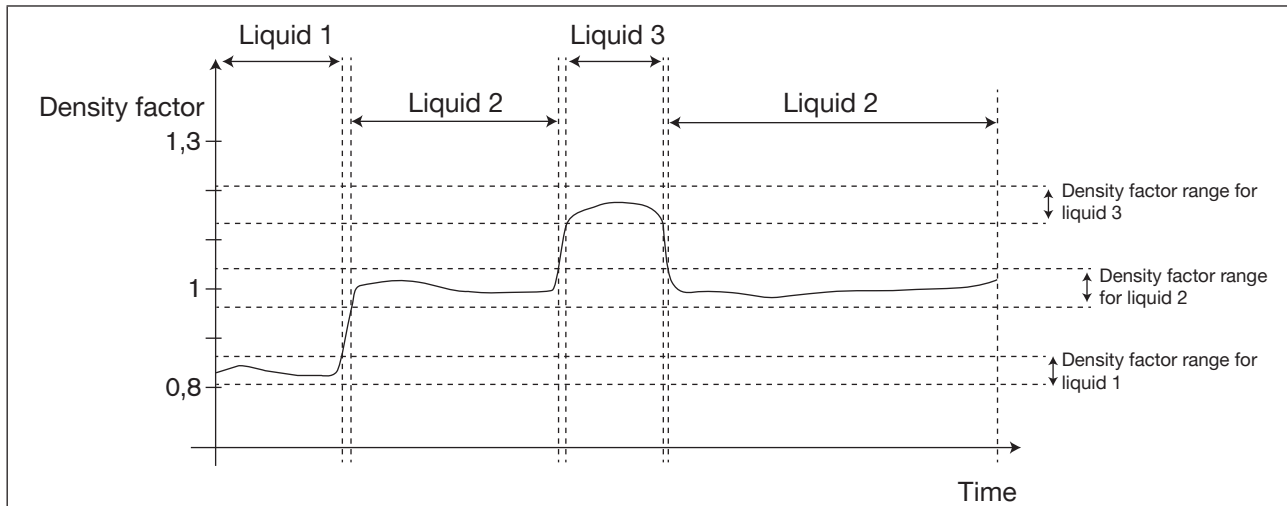

Figure 28: Ranges of the density factor for different liquids flowing through the pipe

To identify the liquid flowing through the pipe, do the following:

- Connect an analogue output or a digital output configured as a frequency output to a PLC for example.\*)
- Associate the density factor to the used analogue output or digital output. See [chpt. 17.3.1 Changing the process value and the process value range associated to an analogue output](#) or [chpt. 17.5.3 Configuring a digital output as a frequency output](#).\*)
- Make sure you exactly know the ranges of the density factor values for the different liquids that may flow through the pipe.
- If necessary, select the type of temperature compensation for one of the liquids. See [chpt. 14.8.10](#).
- Configure the ranges in the PLC so that you can clearly identify which liquid is flowing through the pipe.

\*) Only variant with outputs.

## 14.9 Setting the parameters of the acoustic transmission factor (optional feature)

### 14.9.1 What is the acoustic transmission factor?

The acoustic transmission factor makes it possible to know the quality of the transmission of sound in the liquid thus the reliability of the measurements.

Indeed, the wave transit time in the liquid and the wave amplitude change depending on the following criteria:

- the type of liquid: aqueous solution, oil solution, emulsion, etc.
- the presence of gas bubbles
- the presence of solid particles
- the liquid temperature
- the DN of the pipe

The acoustic transmission factor, given in %, is calculated on the base of the amplitude changes of the waves. The acoustic transmission factor of water without gas bubbles is equal to 100 % at a water temperature of +23 °C.

The temperature changes of the liquid are not compensated for the measurement of the acoustic transmission factor.

The device measures acoustic transmission factors from 10 % and up.

- If the wave amplitude in a liquid flowing through the pipe is higher than the wave amplitude in water, the measured acoustic transmission factor will be higher than 100 %.
- If the wave amplitude in a liquid flowing through the pipe is lower than the wave amplitude in water, the measured acoustic transmission factor will be lower than 100 %.

Gas bubbles or solid particles in the liquid have a similar effect on the transmission acoustic factor. If the concentration of gas bubbles or solid particles increases in a liquid, the acoustic transmission factor decreases. So, measuring and monitoring the acoustic transmission factor can be used to detect the presence of gas bubbles or solid particles in the liquid.

→ Take into account that special process conditions can have an effect on aging of the sensor thus on the acoustic transmission factor value.

### 14.9.2 Giving a user defined name to the measured acoustic transmission factor

The name is used to identify the process value in the user defined views and in all the menus where the process value is displayed (for example in the **Outputs** menu).

By default, the name associated to the measured acoustic transmission factor is **Acoustic transmis.**

To add a user defined name to the default name, do the following:

- Select the device in the navigation area.
- **SAW sensor**
- **Parameter**
- **Add. meas. values** ----->
- **Acoustic transmission factor** ----->
- **Value name** ----->
- Enter the name. The name can have up to 19 characters.
- **Apply**
- The name is changed.

### 14.9.3 Activating the damping of the acoustic transmission factor and selecting a predefined damping level

The damping makes it possible to damp the fluctuations of the measured values of the acoustic transmission factor:

- On the totalizers
- On the outputs. The damping set for an analog output comes in addition to the damping of the acoustic transmission factor \*)

The damping is not applied to the new measured value, if the 2 following conditions are met:

- a **Low**, **Medium** or **High** damping level is active
- and the variation between 2 values that are measured one after the other is higher than 30 % )

By default, the acoustic transmission factor are not damped.

The **Low** damping level or no damping at all (**None**) are suited for applications or processes that need fast response times.

The **Medium** damping level or the **High** damping level are suited if the acoustic transmission factor change slowly.

- As an alternative to the 3 predefined damping levels **Low**, **Medium** or **High**, you can set your own damping parameters. See chapter [14.9.4](#)

\*) Only variant with outputs.

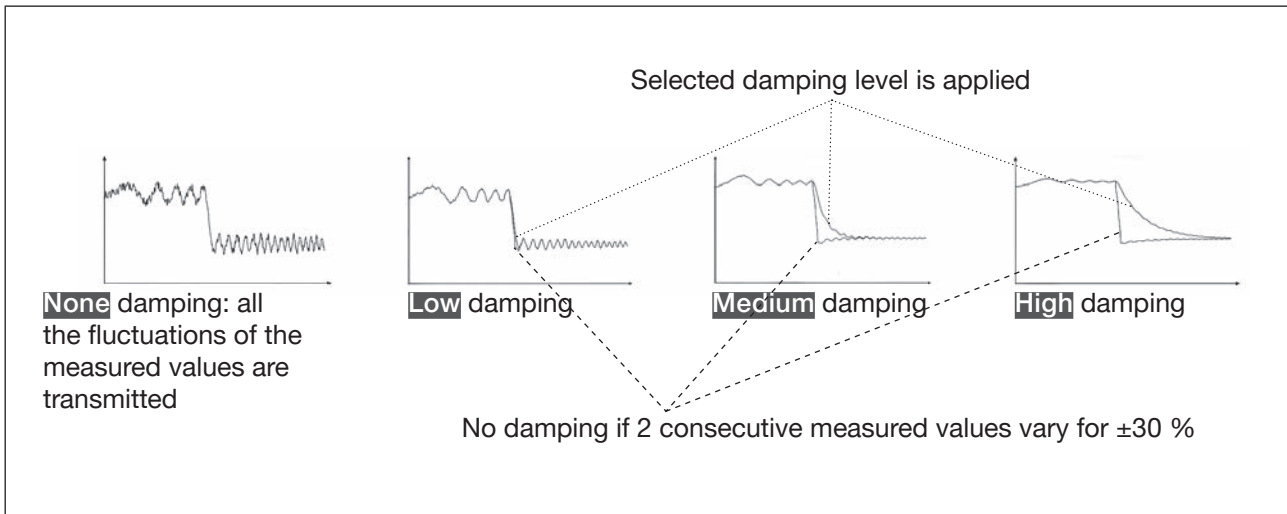

Figure 29: Operation of the available damping levels

Damping level	Response time
None	0 s
Low	1 s
Medium	10 s
High	30 s
Special	...User-defined <b>Response time</b> : see chapter

Table 12: Response times (10%...90%) of the damping levels for the acoustic transmission factor measurements

To set a predefined damping level of the acoustic transmission factor, do the following:

- Select the device in the navigation area.
- **SAW sensor**
- **Parameter**
- **Add. meas. values** ----->
- **Acoustic transmission factor** ----->
- **Damping** ----->

The current settings are displayed.

- Select a damping level between **Low**, **Medium** and **High** ----->

The new settings are displayed.

- **Finish**

✔ The damping of the acoustic transmission factor is active and a predefined damping level is selected.

#### 14.9.4 Activating a user-defined damping of the acoustic transmission factor

The damping makes it possible to damp the fluctuations of the measured values of the acoustic transmission factor:

- On the totalizers
- On the outputs. The damping of the acoustic transmission factor comes in addition to the damping set for each analog output\*)

By default, the measured acoustic transmission factor values are not damped.

To damp the fluctuations of the measured values, you can:

- Either select 1 of the 3 predefined damping levels: **Low**, **Medium** or **High**. See chpt. .
- Or you can set your own damping parameters with the **Special** damping.

With the **Special** damping, you can set 2 parameters:

- a user-defined **Response time** in seconds,
- the **Jump threshold**, i.e. a user-defined percentage. If 2 consecutive measured values vary for  $\pm$  the percentage, no damping is applied to the second measured value.

To set your own damping parameters of the measured acoustic transmission factor, do the following:

- Select the device in the navigation area.
- **SAW sensor**
- **Parameter**
- **Add. meas. values** -----▶
- **Acoustic transmission factor** -----▶
- **Damping** -----▶

The current settings are displayed.

- Select **Special** -----▶
- Set the value of the **Response time** -----▶
- Select if the **Jump threshold** is enabled or disabled -----▶
- If the **Jump threshold** is enabled, set the value. -----▶

The new settings are displayed.

- **Finish**

The special damping of the acoustic transmission factor is active.

\*) Only variant with outputs.

### 14.9.5 Deactivating the damping of the acoustic transmission factor

By default, the acoustic transmission factor are not damped.

If the damping of the acoustic transmission factor is active, do the following to deactivate it:

- Select the device in the navigation area.
- **SAW sensor**
- **Parameter**
- **Add. meas. values** ----->
- **Acoustic transmission factor** ----->
- **Damping** ----->

The current settings are displayed.

- Select **None** ----->

The new settings are displayed.

- **Finish**

✔ The damping of the acoustic transmission factor is inactive.

### 14.9.6 Changing the error limits, the warning limits and the hysteresis of the acoustic transmission factor

To change the error limits, the warning limits and the hysteresis of the acoustic transmission factor, do the following:

- Select the device in the navigation area.
- **SAW sensor**
- **Parameter**
- **Add. meas. values** ----->
- **Acoustic transmission factor** ----->
- **Limits** ----->
- **Settings** ----->

The current settings are displayed.

- Set the high error limit ----->
- Set the low error limit ----->
- Set the high warning limit ----->
- Set the low warning limit ----->
- Set the hysteresis value ----->

The new settings are displayed.

- **Finish**

✔ The limit values and the hysteresis value are changed.



### 14.9.7 Activating the monitoring of the acoustic transmission factor

To be informed when the concentration of gas bubbles or solid particles changes in the liquid, monitor the acoustic transmission factor.

A monitored value can be:

- in the normal operating range
- in the warning range
- in the error range

You can set 4 limit values: 2 error limits and 2 warning limits.

→ To set the limit values, see chpt. [14.9.6 Changing the error limits, the warning limits and the hysteresis of the acoustic transmission factor.](#)

Figure 23 in [14.4.5](#) explains how the device reacts when the monitored value enters in another range (for example, from the normal range into the warning range). The reaction time depends on the hysteresis value and if the monitored value increases or decreases.

By default, the monitoring of the acoustic transmission factor and the diagnostics are all disabled.

To activate the monitoring of the acoustic transmission factor, do the following:

→ Select the device in the navigation area.

→ **SAW sensor**

→ **Parameter**

→ **Add. meas. values** ----->

→ **Acoustic transmission factor** ----->

→ **Limits** ----->

→ **Active** ----->

→ Select **Yes**.

✓ The monitoring of the acoustic transmission factor is active and the device status will change depending on the limits that have been set.

→ You can configure the behaviour of an analogue output depending on the status of the device. See chpt. [17.3.3 Configuring the behaviour of an analogue output depending on the status of the device.](#)\*)

→ You can configure a digital output to switch every time a specific event is generated. See chpt. [17.5.1 Configuring a digital output as an on/off output.](#)\*)

→ To enable the monitoring, i.e. to be informed when the value of the acoustic transmission factor is outside the normal range, enable the diagnostics. See chpt. [11.9 Activating the diagnostics functions.](#)

\*) Only variant with outputs.

## 14.9.8 Deactivating the monitoring of the acoustic transmission factor

By default, the acoustic transmission factor values are not monitored.

If the monitoring of the acoustic transmission factor is active, do the following to deactivate it:

- Select the device in the navigation area.
- **SAW sensor**
- **Parameter**
- **Add. meas. values** ----->
- **Acoustic transmission factor** ----->
- **Limits** ----->
- **Active** ----->
- Select **No.**

The monitoring of the acoustic transmission factor is inactive.

## 14.9.9 Resetting the default values of the error limits, the warning limits and the hysteresis of the acoustic transmission factor

The default values of the error limits, the warning limits and the hysteresis of the acoustic transmission factor are the following:

- high error value: 195%
- low error value: 5%
- high warning value: 190%
- low warning value: 10%
- value of the hysteresis: 1%

To reset the default values of the error limits, the warning limits and the hysteresis of the acoustic transmission factor, do the following:

- Select the device in the navigation area.
- **SAW sensor**
- **Parameter**
- **Add. meas. values** ----->
- **Acoustic transmission factor** ----->
- **Limits** ----->
- **Reset to default** ----->
- **Finish**

The limit values and the hysteresis value are reset.

### 14.9.10 Resetting the default values of all the acoustic transmission factor parameters

To reset all the default values of all the acoustic transmission factor parameters, do the following:

- Select the device in the navigation area.
- **SAW sensor**
- **Parameter**
- **Add. meas. values** ----->
- **Acoustic transmission factor** ----->
- **Reset to default** ----->
- **Finish**

✓ All the acoustic transmission factor parameters are reset.

## 14.10 Diagnostics: monitoring special events in the process, on the sensor or on the electronics

The device can inform that a special event occurs in the process, on the sensor or on the electronics\*) of the device. It can also be set to normal operation for each event.

The possible events are listed in [Table 13](#), [Table 14](#). and [Table 15](#)

→ To be informed if a special event occurs in the process, on the sensor or on the electronics\*), configure the diagnostics as shown in the flowchart in [Figure 30](#).

You can be informed through the colour of the status indicator and/or through a message and/or through one or several outputs\*) as shown in the flowcharts in [Figure 31](#) and in [Figure 32](#).

\*) *Only variant with outputs.*

Special event in the process:

Special event in the process	Meaning	Special condition
<b>Not totally filled</b>	The tube is not totally filled. If the parameter <b>Refresh time</b> is set to <b>Very short</b> , the event <b>Not totally filled</b> cannot be monitored.	Not all the sensors are in contact with the liquid.
<b>Liquid out of range</b>	The speed of sound in the liquid is out of range.	DN08, 3/8", 1/2": The speed of sound in the liquid is lower than 1000 m/s or higher than 2000 m/s. DN15 and above, 3/4" and above: The speed of sound in the liquid is lower than 800 m/s or higher than 2300 m/s.
<b>Unstable flow</b>	The flow rate is not stable.	The standard deviation of the flow rate measurements is too high.
<b>Low flow cut off</b>	The cut-off value of the flow rate has been used.	The cut-off function must be enabled: see chpt. <a href="#">14.4.9 Enabling the cut-off function</a> .

Special event in the process	Meaning	Special condition
<b>Change of liquid</b>	A different liquid flows in the pipe.	The speed of sound in the liquid has changed by more than 3 m/s in 1 second.
<b>Backward flow</b>	The liquid flows in the opposite direction as the one set in chpt. <a href="#">16.4</a> <u>Setting the direction of the flow.</u>	-

Table 13: *Diagnostics: special events in the process*

Special event occurring on the sensor:

Special event on the sensor	Meaning	Special condition
<b>Sound cond. out of range</b>	There are gas bubbles or solid particles in the liquid.	-

Table 14: *Diagnostics: special events on the sensor*

Special event on the electronics:\*)

Special event on the electronics	Meaning	Special condition
<b>Output 1, open loop</b> <b>Output 2, open loop</b>	There is a connection problem on the related output.	The related analogue output must not be disabled. See chpt. <a href="#">17.4</a> <u>Disabling an analogue output</u>
<b>Output 1, Diag. error</b> <b>Output 2, Diag. error</b>	There is a connection problem on the related output or a high resistance is detected in the loop.	The related analogue output must not be disabled. See chpt. <a href="#">17.4</a> <u>Disabling an analogue output</u>
<b>Output 1 overload</b> <b>Output 2 overload</b>	An overload has been detected on the related digital output. The output has switched.	-

Table 15: *Diagnostics: special events on the electronics*

\*) *Only variant with outputs.*

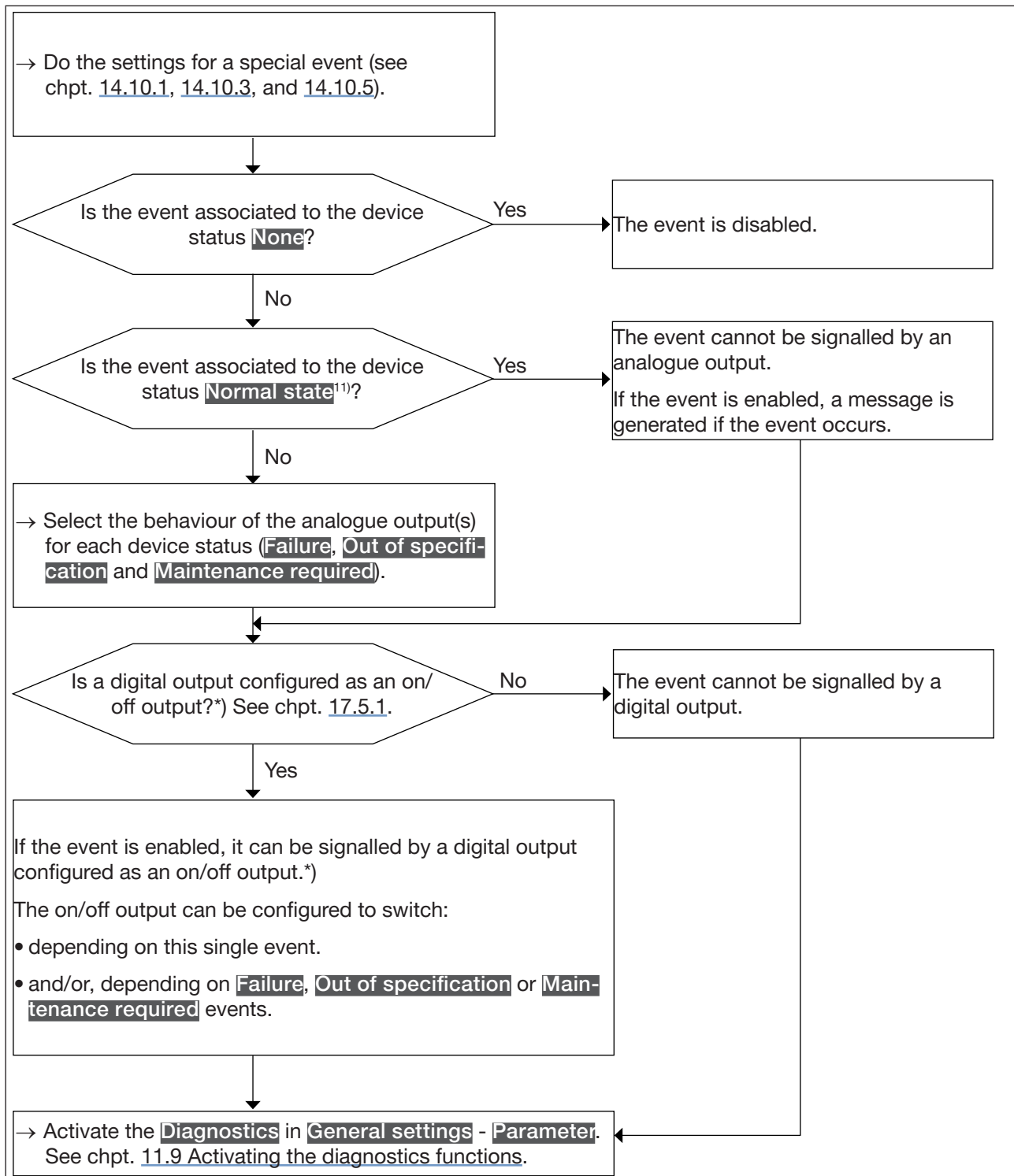

MAN 1000417092 EN Version: C Status: RL (released | freigegeben) printed: 21.05.2021

Figure 30: Flowchart: configuration of the diagnostics

11) **Normal state** means that only a message is generated when the event occurs but the event is considered to be part of the normal operating of the process, or of the electronics, or of the sensor.

\*) Only variant with outputs.

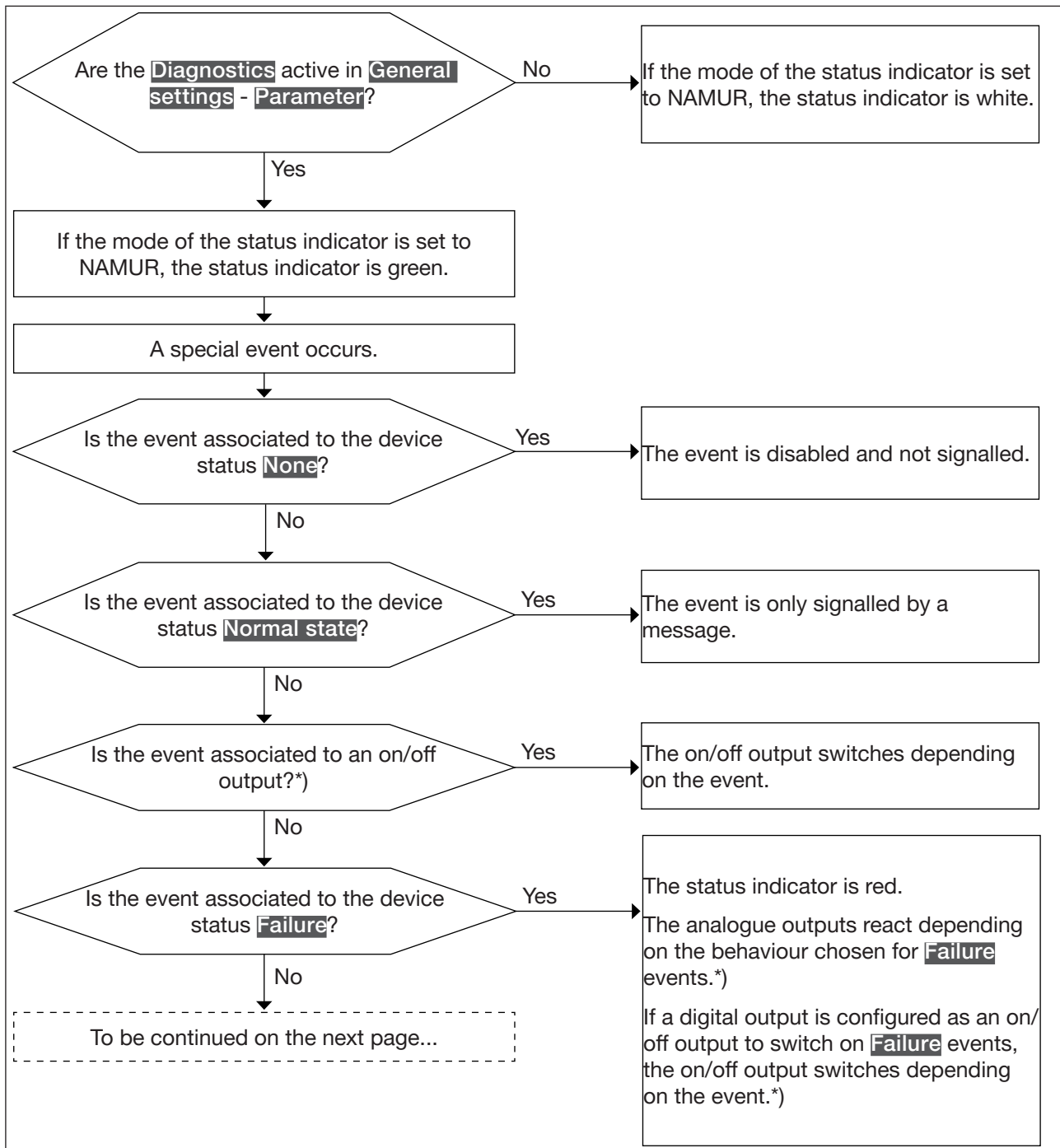

Figure 31: Flowchart: operating of the diagnostics when a special event occurs (part 1/2)

\*) Only variant with outputs.

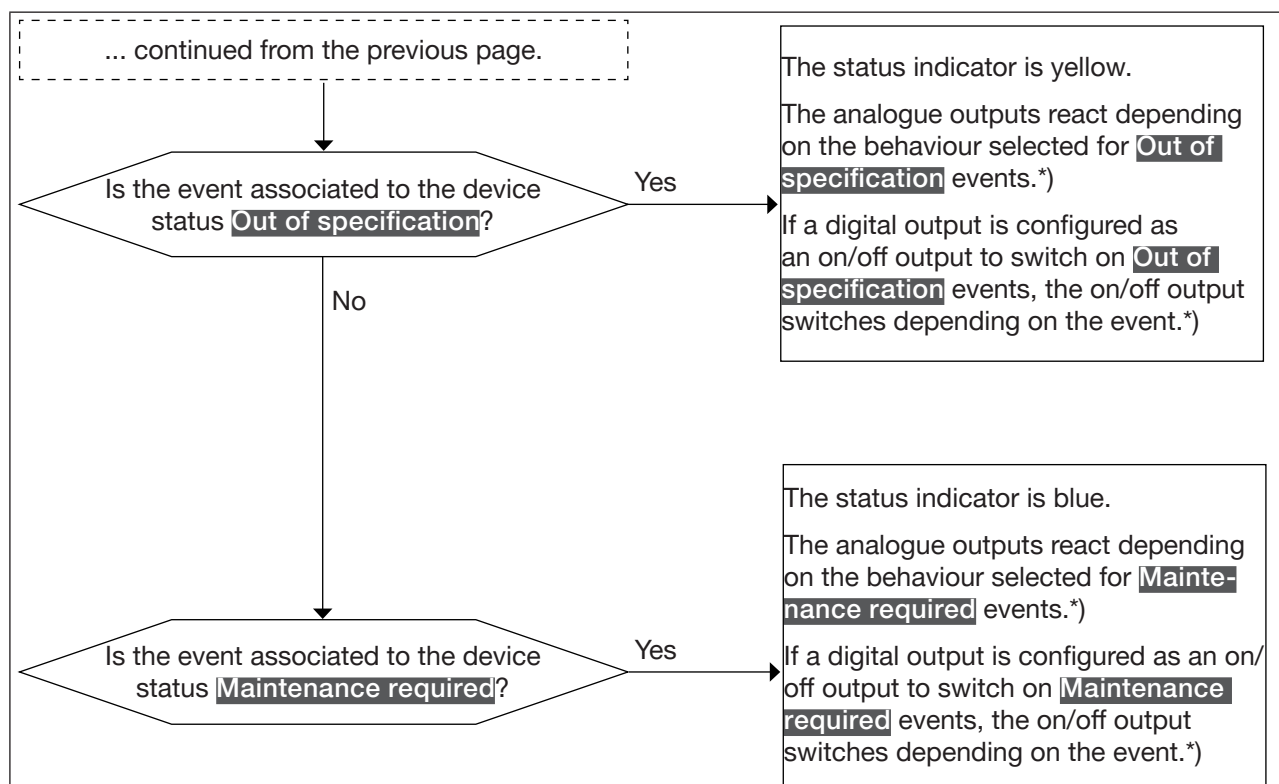

Figure 32: Flowchart: operating of the diagnostics when a special event occurs (part 2/2)

\*) Only variant with outputs.

### 14.10.1 Enabling the diagnostics for special events in the process

By default, all the diagnostics related to the process are disabled.

To enable the diagnostics for special events related to the process, do the following:

- Select the device in the navigation area.
- **SAW sensor**
- **Parameter**
- **Diag events** ----->
- **Process** ----->
- Select the special event ----->
- Assign a device status to the special event: **Failure**, **Out of specification**, **Maintenance required** or **Normal state**.

✓ The diagnostics of the special event are enabled.

- To be informed that an event occurs, activate all the diagnostics on the device. See chpt. [11.9 Activating the diagnostics functions](#).

### 14.10.2 Disabling the diagnostics for special events in the process

By default, all the diagnostics related to the process are disabled.

To disable the diagnostics for special events in the process, do the following:

→ Select the device in the navigation area.

→ **SAW sensor**

→ **Parameter**

→ **Diag events** ----->

→ **Process** ----->

→ Select the special event ----->

→ Select **None** ----->

✔ The diagnostics for the special event are disabled.

### 14.10.3 Enabling the diagnostics for special events on the electronics

Only for variant with outputs.

By default, all the diagnostics related to the electronics are disabled.

To enable the diagnostics for special events on the electronics, do the following:

→ Select the device in the navigation area.

→ **SAW sensor**

→ **Parameter**

→ **Diag events** ----->

→ **Electronic** ----->

→ Select the special event ----->

→ Assign a device status to the special event: **Failure**, **Out of specification**, **Maintenance required** or **Normal state**.

✔ The diagnostics of the special event are enabled.

→ To be informed that an event occurs, activate all the diagnostics on the device. See chpt. [11.9 Activating the diagnostics functions](#).



#### 14.10.4 Disabling the diagnostics for special events on the electronics

Only for variant with outputs.

By default, all the diagnostics related to the electronics are disabled.

To disable the diagnostics for special events on the electronics, do the following:

→ Select the device in the navigation area.

→ **SAW sensor**

→ **Parameter**

→ **Diag events** ----->

→ **Electronic** ----->

→ Select the special event ----->

→ Select **None** ----->

✔ The diagnostics of the special event are disabled.

#### 14.10.5 Enabling the diagnostics for special events on the sensor

By default, all the diagnostics related to the sensor are disabled.

To enable the diagnostics for special events related to the sensor, do the following:

→ Select the device in the navigation area.

→ **SAW sensor**

→ **Parameter**

→ **Diag events** ----->

→ **Sensor** ----->

→ Select the special event ----->

→ Assign a device status to the special event: **Failure**, **Out of specification**, **Maintenance required** or **Normal state**.

✔ The diagnostics of the special event are enabled.

→ To be informed that an event occurs, activate all the diagnostics on the device. See chpt. [11.9 Activating the diagnostics functions](#).

## 14.10.6 Disabling the diagnostics for special events on the sensor

By default, all the diagnostics related to the sensor are disabled.

But if all or some diagnostics related to events occurring on the sensor are enabled, do the following to disable them all:

To disable the diagnostics for the special events on the sensor, do the following:

→ Select the device in the navigation area.

→ **SAW sensor**

→ **Parameter**

→ **Diag events** -----▶

→ **Sensor** -----▶

→ Select the special event -----▶

→ Select **None** -----▶

✔ The diagnostics of the special event are disabled.

## 14.11 Getting as accurate measurements of the volume flow rate or the liquid velocity as possible

To get as accurate measurements of the volume flow rate or the liquid velocity as possible, you can activate the compensation of the kinematic viscosity (in mm<sup>2</sup>/s).

The following kinematic viscosity compensations are available:

- for water or a liquid whose viscosity  $\nu$  (in mm<sup>2</sup>/s) varies with the temperature  $T$  (in °C) like the viscosity of water and in the same range as water. Default setting. The related equation is:

$$\nu = \frac{1}{0,555029 + 0,020217T + 9,9 \cdot 10^{-5}T^2}$$

→ To activate the viscosity compensation for water, see chpt. [14.11.1](#).

- for a liquid with a constant viscosity. To be chosen if the liquid temperature is constant and thus the viscosity of the liquid is constant. The related equation is:

$$\nu = a$$

→ To activate the viscosity compensation for a liquid whose viscosity is constant, see chpt. [14.11.2](#).

- for a liquid with a linear compensation curve. To be chosen if the viscosity of the liquid varies in a linear way depending on the liquid temperature. The related equation is:

$$\nu = a + bT$$

→ To activate the viscosity compensation for a liquid with a linear viscosity compensation curve, see chpt. [14.11.3](#).

- for a liquid with a quadratic compensation curve. To be chosen if the viscosity of the liquid varies in a quadratic way depending on the liquid temperature. The related equation is:

$$\nu = a + bT + cT^2$$

→ To activate the viscosity compensation for a liquid with a quadratic viscosity compensation curve, see chpt. [14.11.4](#).

- for a liquid with an inverse quadratic compensation curve. To be chosen if the viscosity of the liquid varies in an inverse quadratic way depending on the liquid temperature, but the viscosity range is different from the one of water. The related equation is:

$$\nu = \frac{1}{a + bT + cT^2}$$

→ To activate the viscosity compensation for a liquid with an inverse quadratic viscosity compensation curve, see chap [14.11.5](#).

### 14.11.1 Activating the viscosity compensation for water like liquids

To activate the viscosity compensation of water-like liquids, do the following:

- Select the device in the navigation area.
- **SAW sensor**
- **Parameter**
- **Viscosity compensation** ----->
- **Settings** ----->

The current settings are displayed.

- Select **Water**

The new settings are displayed.

- **Finish**

The viscosity compensation for a water-like liquid is active.

### 14.11.2 Activating the compensation for a liquid with a constant viscosity

The kinematic viscosity of a liquid can be constant either because the temperature of the liquid is constant or because the temperature changes have a very low effect on the viscosity.

To activate the compensation for a liquid with a constant viscosity, do the following:

- Select the device in the navigation area.
- **SAW sensor**
- **Parameter**
- **Viscosity compensation** ----->
- **Settings** ----->

The current settings are displayed.

- Select **Constant** ----->

- Set the value of the liquid viscosity in the displayed units (mm<sup>2</sup>/s). You must enter a positive value. For example, to set the kinematic viscosity value for oil at 20 °C, i.e. 89 mm<sup>2</sup>/s, enter 8,900000E+01.

The new settings are displayed.

- **Finish**

The compensation for a liquid with a constant viscosity is active.

### 14.11.3 Activating the compensation for a liquid with a linear viscosity compensation curve

To activate the compensation for a liquid with a viscosity that changes in a linear way with the liquid temperature, do the following:

- Select the device in the navigation area.
- **SAW sensor**
- **Parameter**
- **Viscosity compensation** ----->
- **Settings** ----->

The current settings are displayed.

- Select **Linear** ---->
- Set the value of the constant a of the linear curve, in the displayed units (mm<sup>2</sup>/s), and in the scientific notation. For example, to set the value 0,03724, enter 3.724000E-02 or, to set the value 372,4, enter 3.724000E+02.
- Set the value of the constant b of the linear curve, in the displayed units, and in the scientific notation.

The new settings are displayed.

- **Finish**

The compensation for a liquid with a linear compensation curve is active.

If the calculated result of the equation is negative or equal to 0 (for example if the fluid temperature is not in the range covered by the equation, or if a wrong constant value has been entered), the compensated volume flow is incorrect and the error message **Viscosity compensation failed** is displayed. If the message is displayed, do the following:

- Make sure the fluid temperature is in the range covered by the equation.
- Make sure you have entered correct a constant value.

### 14.11.4 Activating the compensation for a liquid with a quadratic viscosity compensation curve

To activate the compensation for a liquid with a quadratic viscosity compensation curve, do the following:

- Select the device in the navigation area.
- **SAW sensor**
- **Parameter**
- **Viscosity compensation** ----->
- **Settings** ----->

The current settings are displayed.

- Select **Quadratic**
- Set the value of constant *a* of the quadratic curve, in the displayed units (mm<sup>2</sup>/s), and in the scientific notation. For example, to set the value 0,03724, enter 3.724000E-02 or, to set the value 372,4, enter 3.724000E+02.
- Set the value of constant *b* of the quadratic curve, in the displayed units, and in the scientific notation.
- Set the value of constant *c* of the quadratic curve, in the displayed units, and in the scientific notation.

The new settings are displayed.

- **Finish**

The compensation for a liquid with a quadratic compensation curve is active.

If the calculated result of the equation is negative or equal to 0 (for example if the fluid temperature is not in the range covered by the equation, or if wrong constant values have been entered), the compensated volume flow is incorrect and the error message **Viscosity compensation failed** is displayed. If the message is displayed, do the following:

- Make sure the fluid temperature is in the range covered by the equation.
- Make sure you have entered correct constant values.

### 14.11.5 Activating the compensation for a liquid with an inverse quadratic viscosity compensation curve

To activate the compensation for a liquid with an inverse quadratic compensation curve, do the following:

- Select the device in the navigation area.
- **SAW sensor**
- **Parameter**
- **Viscosity compensation** -----▶
- **Settings** -----▶

The current settings are displayed.

- Select **Inverse quadratic**
- Set the value of constant *a* of the quadratic curve, in the displayed units (mm<sup>2</sup>/s), and in the scientific notation. For example, to set the value 0,03724, enter 3.724000E-02 or, to set the value 372,4, enter 3.724000E+02.
- Set the value of constant *b* of the quadratic curve, in the displayed units, and in the scientific notation.
- Set the value of constant *c* of the quadratic curve, in the displayed units, and in the scientific notation.

The new settings are displayed.

- **Finish**

The compensation for a liquid with an inverse quadratic compensation curve is active.

If the calculated result of the equation is negative or equal to 0 (for example if the fluid temperature is not in the range covered by the equation, or if wrong constant values have been entered), the compensated volume flow is incorrect and the error message **Viscosity compensation failed** is displayed. If the message is displayed, do the following:

- Make sure the fluid temperature is in the range covered by the equation.
- Make sure you have entered correct constant values.

### 14.11.6 Resetting the default values of the viscosity compensation parameters

To reset the default values of the viscosity compensation parameters, do the following:

- Select the device in the navigation area.
- **SAW sensor**
- **Parameter**
- **Viscosity compensation** -----▶
- **Reset to default** -----▶
- **Finish**

The viscosity compensation parameters are reset.

## 14.12 Setting the refresh time

### 14.12.1 Use case of the refresh time

The refresh time is the minimum time needed to update a measurement value. The refresh time has no effect on the damping of the measured values.

The refresh time of the temperature values is a constant but the refresh time of the other measurement values can be adapted to the process:

- A very short refresh time is needed if the process requires quick measurement updates, for example for very short dosings.
- A long refresh time is sufficient if for example there are slow flow rate changes in the process.

### 14.12.2 Changing the refresh time

3 refresh times are available:

- a **Long** refresh time, i.e. the duration between 2 measurement updates is approximately 100 ms.
- a **Short** refresh time, i.e. the duration between 2 measurement updates is approximately 70 ms. Default setting.
- a **Very short** refresh time, i.e. the duration between 2 measurement updates is approximately 30 ms.



If the very short refresh time is set:

- The diagnostics event **Not totally filled** is not available
- The measurement deviation for a flow rate between 10% of the full scale and the full scale is  $\pm 0,6\%$
- The repeatability for a flow rate between 10% of the full scale and the full scale is  $\pm 0,3\%$



If a digital output\*) is configured as a pulse output, the following durations must be added to the last received pulse:

- 50 ms, if the refresh time is set to **Very short**,
- 80 ms, if the refresh time is set to **Short**,
- 140 ms, if the refresh time is set to **Long**.

To change the refresh time, do the following:

- Select the device in the navigation area.
- **SAW sensor**
- **Parameter**
- **Refresh time** ----->
- Select the refresh time.
- ✓ The refresh time is changed.

\*) Only variant with outputs.



## 15 SAW SENSOR - DIAGNOSTICS

### 15.1 Reading out the generated events related to the device

To read out the generated events related to the monitoring of the process value limits and to the diagnostics events, and to read out the possible associated behaviour of the device, do the following:

→ Select the device in the navigation area.

→ **SAW sensor**

→ **Diagnostics**

→ **Device** ----->

→ **Status** ----->

✓ The status is displayed.

→ **Finish**

### 15.2 Reading out the flow direction that has been set

To read out the flow direction that has been set in [chpt. 16.4 Setting the direction of the flow](#), do the following:

→ Select the device in the navigation area.

→ **SAW sensor**

→ **Diagnostics**

→ **Device** ----->

→ **Flow direction** ----->

✓ The flow direction is displayed.

### 15.3 Reading out the temperatures of the electronic boards and of the liquid

To read out the measured temperatures of the electronic boards and of the liquid, do the following:

→ Select the device in the navigation area.

→ **SAW sensor**

→ **Diagnostics**

→ **Device** ----->

→ **Temperatures** ----->

✓ The temperatures are displayed.

→ **Finish**

## 15.4 Reading out the refresh time that has been set

To read out the refresh time that has been set in [chpt. 14.12 Setting the refresh time](#), do the following:

- Select the device in the navigation area.
- **SAW sensor**
- **Diagnostics**
- **Device** ----->
- **Refresh time** ----->

✓ The refresh time is displayed.

## 15.5 Reading out the operating hours of the device

To read out the operating hours of the device, do the following:

- Select the device in the navigation area.
- **SAW sensor**
- **Diagnostics**
- **Device** ----->
- **Operating hours** ----->

✓ The operating hours are displayed.

## 15.6 Reading out the operating hours of the measurement board

To read out the operating hours of the measurement board, do the following:

- Select the device in the navigation area.
- **SAW sensor**
- **Diagnostics**
- **Device** ----->
- **Operating hours (measurement board)** ----->

✓ The operating hours are displayed.

## 15.7 Reading out the diagnostics related to the output values

Only variant with outputs.

The outputs values give the values of the process values at a certain time. See chpt. 17. To read out diagnostics related to the output values, do the following:

- Select the device in the navigation area.
- **SAW sensor**
- **Diagnostics**
- **Output values** ----->

✔ The output values are displayed.

## 15.8 Reading out the diagnostics events that occurred in the process

To read out the diagnostics events that occurred in the process, and to read out the possible associated behaviour of the device, do the following:

- Select the device in the navigation area.
- **SAW sensor**
- **Diagnostics**
- **Diag. events** ----->
- **Process** ----->
- **Status** ----->

✔ The status is displayed.

- **Finish**

## 15.9 Reading out the diagnostics events that occurred on the electronics

To read out the diagnostics events that occurred on the electronics, and to read out the possible associated behaviour of the device, do the following:

- Select the device in the navigation area.
- **SAW sensor**
- **Diagnostics**
- **Diag. events** ----->
- **Electronic** ----->
- **Status** ----->

✔ The status is displayed.

- **Finish**

## 15.10 Reading out the diagnostics events that occurred on the sensor

To read out the status of the diagnostics events that occurred on the sensor, do the following:

- Select the device in the navigation area.
- **SAW sensor**
- **Diagnostics**
- **Diag. events** ----->
- **Sensor** ----->
- **Status** ----->
- ✓ The status is displayed.
- **Finish**

## 15.11 Reading out the diagnostics related to the monitored limits

To read out the diagnostics related to the monitored limits, do the following:

- Select the device in the navigation area.
- **SAW sensor**
- **Diagnostics**
- **Limits** ----->
- **Status** ----->
- ✓ The status is displayed.
- **Finish**

## 15.12 Reading out if a process value is in the monitored range

This menu point allows you to read out if a process-value is inside or outside the monitored limits. The monitoring of the process-value limits must be active. Refer to chpt [14.4.5.](#), [14.5.5](#) and [14.6.5.](#)

To read out if a process value is inside or outside the monitored limits do the following:

- Select the device in the navigation area.
- **SAW sensor**
- **Diagnostics**
- **Limits** ----->
- Select the process value.
- **Status** ----->
- ✓ The status is displayed.
- **Finish**

## 16 SAW SENSOR - MAINTENANCE

### 16.1 User levels of the editable menu items

Menu item of the <b>SAW sensor</b> - <b>Maintenance</b> menu	Minimum user level
<b>Device information</b>	basic user
<b>Flow direction</b>	<b>Installer</b>
<b>Calibration</b>	<b>Installer</b>
<b>Device verification</b>	<b>Installer</b>
<b>Simulation</b>	<b>Installer</b>

### 16.2 Default settings

You can find the default settings of the device in the CANopen supplement for the Type 8098 at [www.burkert.com](http://www.burkert.com)

→ Before making any change in the settings, use the Bürkert Communicator software to print a pdf file with all the default settings of the device.

### 16.3 Reading out device information

#### 16.3.1 Reading out the order numbers of the device, the transmitter board and the measurement board

To read out the order numbers of the device, the transmitter board and the measurement board, do the following:

- Select the device in the navigation area.
- **SAW sensor**
- **Maintenance**
- **Device information** -----▶
- **ID numbers** -----▶

✔ The order numbers are displayed.

### 16.3.2 Reading out the serial numbers of the device, the transmitter board and the measurement board

To read out the serial numbers of the device, the transmitter board and the measurement board, do the following:

- Select the device in the navigation area.
- **SAW sensor**
- **Maintenance**
- **Device information** ----->
- **Serial numbers** ----->

✔ The serial numbers are displayed.

### 16.3.3 Reading out the hardware and software versions of the transmitter board and of the measurement board

To read out the hardware and software versions of the transmitter board and of the measurement board, do the following:

- Select the device in the navigation area.
- **SAW sensor**
- **Maintenance**
- **Device information** ----->
- **Versions** ----->

✔ The hardware and software versions are displayed.

### 16.3.4 Reading out the characteristics of the measurement tube

To read out the characteristics of the measurement tube, do the following:

- Select the device in the navigation area.
- **SAW sensor**
- **Maintenance**
- **Device information** ----->
- **Pipe characteristics** ----->

✔ The measurement tube characteristics are displayed.

### 16.3.5 Checking the correct operation of the sensor

You can check the correct operation of the sensor by comparing the current measured values of some parameters with their reference values. The reference values depend on the conditions of your process:

- If you measure water at 23 °C ±5 °C (73.4 °F ±9 °F) that is free of gas bubbles and free of solids, then the conditions of your process are similar to the calibration conditions of the device at the manufacturer. The reference values are those after the device calibration and they can be read in the menu **Device verification**.
- If you do not measure water at 23 °C ±5 °C (73.4 °F ±9 °F) or the liquid is not water, then the reference values are in the PDF file that you have generated with the Bürkert Communicator at the following times:
  - After the first commissioning of the device. Refer to chapter [10 Commissioning](#)
  - After the last maintenance operation

To check the correct operation of the sensor, do the following:

Open the menu **Device verification**:

→ Select the device in the navigation area.

→ **SAW sensor**

→ **Maintenance**

→ **Device verification** ----->

✓ The values of the parameters are displayed.

→ Calculate the deviation for each parameter that is listed in [Table 16](#) or in [Table 17](#). Use the following formula:

$$\frac{|\text{current measured value} - \text{reference value}|}{\text{reference value}} = \text{deviation}$$

- If you measure water at 23 °C ±5 °C (73.4 °F ±9 °F) that is free of gas bubbles and free of solids, then use the values that are displayed in the parameters from columns A and B of [Table 16](#).

Menu item	A	B
	Current measured value of the parameter	Reference value of the parameter after calibration at the manufacturer
<b>Density factor</b>	<b>Density factor</b>	<b>Density factor fact. cal.</b>
<b>Acoustic transmission factor</b>	<b>Acoustic transmission factor</b>	<b>Acoustic transmission factor fact. cal.</b>
<b>Amplitudes</b>	<b>SAW signal</b>	<b>SAW signal fact. calibration</b>
	<b>Signal WG1 13</b>	<b>Signal WG1 13 fact. calibration</b>
<b>Times of flight</b>	<b>A0</b>	<b>A0 fact. calibration</b>
	<b>WG1</b>	<b>WG1 fact. calibration</b>

Table 16: Parameter values to compare if the measured fluid is water at 23 °C ±5 °C (73.4 °F ±9 °F)

- If you do not measure water at 23 °C ±5 °C (73.4 °F ±9 °F) or the fluid is not water, then use the values of the same parameter in the menu **Device verification** and in the PDF file. Refer to [Table 17](#).

Menu item	Current measured value of the parameter in the menu <b>Device verification</b> and in the PDF file
<b>Density factor</b>	<b>Density factor</b>
<b>Acoustic transmission factor</b>	<b>Acoustic transmission factor</b>
<b>Amplitudes</b>	<b>SAW signal</b>
	<b>Signal WGx yz</b>
<b>Times of flight</b>	<b>A0</b>
	<b>WGx</b>

Table 17: Parameter values to compare if the measured fluid is not water or the water does not have a temperature of 23 °C ±5 °C (73.4 °F ±9 °F)

→ Evaluate the deviations of all parameters:

- If the deviations of all parameters are less than the values that are given in [Table 18](#), then the sensor operates correctly.
- If the deviation of at least one parameter exceeds the value that is given in [Table 18](#), then the sensor can possibly be defect. Contact Bürkert.

Parameter	Deviation	
<b>Density factor</b>	> 10%	
<b>Acoustic transmission factor</b>	> 25%	
<b>Amplitudes</b>	<b>SAW-Signal</b>	> 25%
	<b>Signal WGx yz</b>	> 25%
<b>Times of flight</b>	<b>A0</b>	> 10%
	<b>WGx</b>	> 10%

Table 18: Deviation values for a defect sensor

### 16.3.6 Reading out the calibration date at the manufacturer

To read out the calibration date of the device at the manufacturer, do the following:

→ Select the device in the navigation area.

→ **SAW sensor**

→ **Maintenance**

→ **Device verification** ----->

→ **Factory calibration** ----->

✓ The date is displayed.



### 16.3.7 Reading out the fluid type and the fluid temperature during calibration at the manufacturer

To read out the type of liquid and the temperature of the liquid used for the calibration of the device at the manufacturer, do the following:

- Select the device in the navigation area.
- **SAW sensor**
- **Maintenance**
- **Device verification** -----▶
- **Factory calibration** -----▶
- ✔ The medium and the medium temperature are displayed.

### 16.3.8 Reading out the raw measured value of the volume flow rate

The raw value of the volume flow rate is a value that is not damped and to which the active cut-off is not applied.

To read out the raw value of the volume flow rate, do the following:

- Select the device in the navigation area.
- **SAW sensor**
- **Maintenance**
- **Device verification** -----▶
- **Factory calibration** -----▶
- ✔ The volume flow is displayed.

## 16.4 Setting the direction of the flow

By default, if the flow direction is opposite the arrow located on the front of the device, the displayed flow rate values are negative.

If you want that the device displays positive flow rate values, do the following:

- Select the device in the navigation area.
- **SAW sensor**
- **Maintenance**
- **Flow direction** -----▶
- Select **Standard** if the arrow located on the front of the device shows the flow direction, or choose **Reverse** if the flow direction is opposite the arrow located on the front of the device.
- ✔ The flow direction is set and the displayed flow rate values are positive.

## 16.5 Calibrating the offset value of the flow zero point



Adjust this parameter:

- before carrying out a teach-in procedure of the K factor
- after maintenance work
- if the measured flow rate is not zero whereas the flow has been stopped



During the calibration:

- The status indicator is orange, if the operating mode of the status indicator is set to NAMUR (ex-works setting, see chpt. [11.4 Changing the operating mode of the status indicator or switching off the status indicator](#)).
- The NAMUR mode "function check" is active. The outputs react depending on your settings.

Instead of calibrating the offset value of the flow zero point, you can directly set it. See chpt. [16.6 Setting the offset value of the flow zero point](#).

To calibrate the flow zero point, do the following:

- Charge the pipe. To avoid bubbles and air in the pipe, make sure it is full of liquid.
- Select the device in the navigation area.
- **SAW sensor**
- **Maintenance**
- **Calibration** ----->
- **Stand. meas. values** ----->
- **Flow rate** ----->
- **Offset** ----->
- **Zero flow offset by tech-in** ----->

The current settings are displayed.

- Stop the flow and wait until it is completely still. ----->
- Start the calibration of the offset value. ----->

After 30 s, the new settings are displayed.

- **Finish**

✓ The offset value of the flow zero point is calibrated.

If the calibration fails, a message is displayed. Refer to chpt. [20.9 Messages due to calibration or simulation](#).

## 16.6 Setting the offset value of the flow zero point

Instead of setting the offset value of the flow zero point, you can calibrate it. See [chpt. 16.5 Calibrating the offset value of the flow zero point](#).

To enter the offset value of the flow zero point, do the following:

- Select the device in the navigation area.
- **SAW sensor**
- **Maintenance**
- **Calibration** ----->
- **Stand. meas. values** ----->
- **Flow rate** ----->
- **Offset** ----->
- **Enter value** ----->
- Set the value of the offset. Take into account the direction of the flow as set in [chpt. 16.4 Setting the direction of the flow](#)
- **Finish**
- ✔ The offset value of the flow zero point is set.

## 16.7 Setting the K factor

By default, the value of the K factor is 1.0000.

The K factor can be adjusted, if the measured flow rate values differ from the real values.

Instead of setting the K factor, you can calibrate it by using a teach-in procedure. See [chpt. 16.8 Calibrating the K factor by using a teach-in procedure](#).

To enter the value of the K factor, do the following:

- Select the device in the navigation area.
- **SAW sensor**
- **Maintenance**
- **Calibration** ----->
- **Stand. meas. values** ----->
- **Flow rate** ----->
- **K factor** ----->
- **Enter value** ----->
- Set the value of the K factor.
- **Finish**
- ✔ The new K factor value is used.

## 16.8 Calibrating the K factor by using a teach-in procedure



Before any teach-in procedure, calibrate or set the offset value flow zero point of the device. See chpt. [16.5 Calibrating the offset value of the flow zero point](#) or [16.6 Setting the offset value of the flow zero point](#).

By default, the value of the K factor is 1.0000.

The K factor should be adjusted, if the flow rate values that are measured by the device differ from the values that are measured by a reference instrument.

The K factor can be:

- manually adjusted. See chpt. [16.7 Setting the K factor](#)
- automatically calibrated by using a teach-in procedure depending on the flow rate
- automatically calibrated by using a teach-in procedure depending on a known volume

### 16.8.1 Calibrating the K factor by using a teach-in procedure depending on the flow rate

→ Make sure the teach-in conditions are similar to those of the process.

→ In order that the calibration result is correct, make sure the following conditions are met during the teach-in procedure:

- the liquid temperature is stable,
- the flow rate is stable,
- the liquid that flows through the device does not change.

To calibrate the K factor by using a teach-in procedure depending on the flow rate, do the following:

→ Make sure a reference flowmeter is installed in the same pipe as the FLOWave.

→ Charge the pipe. The flow rate must be at least 5% of the full scale.

→ Wait for the flow rate to be stable.

→ Select the device in the navigation area.

→ **SAW sensor**

→ **Maintenance**

→ **Calibration** ----->

→ **Stand. meas. values** ----->

→ **Flow rate** ----->

→ **K factor** ----->

→ **Teach-in by flow rate** ----->

The current K factor is displayed.

→ Start the teach-in procedure.

If the cut-off function is enabled, it is automatically deactivated.

→ Wait for about 30 s: the device is averaging the flow rate.

→ After 30 s, enter the average value of the flow rate that has been measured by the reference flowmeter.

→ The new settings are displayed.

→ **Finish**

✓ The new K factor is used.

✓ If the cut-off function has been automatically deactivated, it is enabled again.

If the calibration fails, a message is displayed. Refer to chpt. [20.9 Messages due to calibration or simulation](#).

## 16.8.2 Calibrating the K factor by using a teach-in procedure depending on a known volume

→ Make sure the teach-in conditions are similar to those of the process.

To calibrate the K factor by using a teach-in procedure depending on a known volume, do the following:

→ Prepare a tank which capacity you know. To make sure to get an accurate K factor, prepare the recommended volume of liquid given in [Table 19](#) and [Table 20](#).

Diameter of the measurement tube	Minimum flow rate at 4 m/s	Recommended volume in litres, to get an accurate K factor
3/8"	11 l/min	19
1/2"	17 l/min	28
DN8	20 l/min	33

Table 19: Recommended volume for a teach-in procedure depending on a known volume

Diameter of the measurement tube	Minimum flow rate at 1 m/s	Recommended volume in litres, to get an accurate K factor
3/4"	12 l/min	19
1"	23 l/min	38
1 1/2"	57 l/min	95
2"	106 l/min	177
2 1/2"	171 l/min	285
3"	250 l/min	417
DN15	15 l/min	26
DN25	42 l/min	69
DN40	92 l/min	154
DN50	149 l/min	249
DN65	245 l/min	408
DN80	355 l/min	472

Table 20: Recommended volume for a teach-in procedure depending on a known volume

- Stop the flow.
- Select the device in the navigation area.
- **SAW sensor**
- **Maintenance**
- **Calibration** -----▶
- **Stand. meas. values** -----▶
- **Flow rate** -----▶
- **K factor** -----▶
- **Teach-in by volume** -----▶

The current K factor is displayed.

- Start the teach-in procedure.

If the cut-off function is enabled, it is automatically deactivated.

- Let the liquid flow through the device into the tank.

When the desired volume is reached:

- Enter the volume that has flown in the tank.

The new settings are displayed.

- **Finish**

✔ The new K factor is used.

✔ If the cut-off function has been automatically deactivated, it is enabled again.

If the calibration fails, a message is displayed. Refer to [chpt. 20.9 Messages due to calibration or simulation](#).

## 16.9 Resetting the flow rate calibration data to its default values

To reset all the flow rate calibration data to its default values, do the following:

- Select the device in the navigation area.
- **SAW sensor**
- **Maintenance**
- **Calibration** -----▶
- **Stand. meas. values** -----▶
- **Flow rate** -----▶
- **Reset to default** -----▶
- **Finish**

✔ All the flow rate calibration data is reset to their default values.

## 16.10 Setting the offset value of the liquid temperature

Instead of setting the offset value of the liquid temperature, you can calibrate it. See [chpt. 16.11 Calibrating the offset value of the liquid temperature](#).

To enter an offset value for the liquid temperature, do the following:

- Select the device in the navigation area.
  - **SAW sensor**
  - **Maintenance**
  - **Calibration** ----->
  - **Stand. meas. values** ----->
  - **Temperature** ----->
  - **Offset** ----->
  - **Enter value** ----->
  - Set the value of the offset.
  - **Finish**
- The offset value of the liquid temperature is set.

## 16.11 Calibrating the offset value of the liquid temperature

Instead of calibrating the offset value of the liquid temperature, you can directly enter it. See [chpt. 16.10 Setting the offset value of the liquid temperature](#).

To calibrate the offset value of the liquid temperature, do the following:

- Make sure a reference temperature sensor is installed in the same pipe as the FLOWave and as near as possible to the FLOWave.
- Charge the pipe.
- Select the device in the navigation area.
- **SAW sensor**
- **Maintenance**
- **Calibration** -----▶
- **Stand. meas. values** -----▶
- **Temperature** -----▶
- **Offset** -----▶
- Make sure the calibration conditions (liquid temperature and ambient temperature) are the same as for the usual measuring conditions.
- Make sure the temperature of the liquid is constant and stable during the calibration procedure.
- **Temper. cal. by ref.** -----▶

The current offset is displayed.

- Start the calibration procedure.
- After 30 s, enter the average value of the liquid temperature that has been measured by the reference temperature sensor.

The new settings are displayed.

- **Finish**
- ✔ The new temperature offset is used.

If the calibration fails, a message is displayed. Refer to [chpt. 20.9 Messages due to calibration or simulation](#). The calibration can fail due to the following causes:

- the calculated offset value is higher than  $\pm 10$  °C
- the integrated temperature sensor is defective



## 16.12 Resetting the offset of the liquid temperature to the default value

To reset the offset of the liquid temperature to the default value, do the following:

→ Select the device in the navigation area.

→ **SAW sensor**

→ **Maintenance**

→ **Calibration** ----->

→ **Stand. meas. values** ----->

→ **Temperature** ----->

→ **Reset to default** ----->

→ **Finish**

✓ The temperature offset is reset to its default value.

## 16.13 Resetting all the calibration data to its default values (standard measurement values)

The calibration data that can be reset is:

- the K factor
- the offset value of the flow zero point
- the offset value of the liquid temperature

To reset all the calibration data to the default values, do the following:

→ Select the device in the navigation area.

→ **SAW sensor**

→ **Maintenance**

→ **Calibration** ----->

→ **Stand. meas. values** ----->

→ **Reset to default** ----->

→ **Finish**

✓ All the calibration data is reset to the default values.

## 16.14 Setting the offset value of the density factor

Instead of setting the offset value of the density factor, you can calibrate it. See chpt. [16.15](#).

To enter an offset value for the density factor, do the following:

- Select the device in the navigation area.
  - **SAW sensor**
  - **Maintenance**
  - **Calibration** -----▶
  - **Add. meas. values** -----▶
  - **Density factor** -----▶
  - **Offset** -----▶
  - **Enter value** -----▶
  - Set the value of the offset.
  - **Finish**.
- ✔ The offset value of the density factor is set.

## 16.15 Calibrating the offset value of the density factor

- Make sure the teach-in conditions are similar to those of the process.
- To get a correct calibration result, make sure that the following conditions are met during the teach-in procedure:
  - The liquid temperature is stable
  - The liquid that flows through the device does not change. Or the liquid is still and the pipe is full and free of bubbles.



During the calibration:

- The status indicator is orange, if the operating mode of the status indicator is set to NAMUR (ex-works setting, see chpt. [11.4 Changing the operating mode of the status indicator or switching off the status indicator](#)).
- The NAMUR mode "function check" is active. The outputs react depending on your settings.

Instead of calibrating the offset value of the density factor, you can directly set it. See chpt. [16.14](#).

To calibrate the offset value of the density factor, do the following:

- Make sure the liquid in the pipe is the liquid to be measured.
- Charge the pipe. To avoid bubbles and air in the pipe, make sure it is full of liquid.
- Select the device in the navigation area.
- **SAW sensor**
- **Maintenance**
- **Calibration** -----▶
- **Add. meas. values** -----▶
- **Density factor** -----▶
- **Offset** -----▶
- **Teach-in by ref.** -----▶

The current settings are displayed.

- Start the calibration of the offset value.
- After 30 s, enter the density factor of the reference liquid. -----▶

The new settings are displayed.

- **Finish**.

✔ The offset value of the density factor is calibrated.

If the calibration fails, a message is displayed. Refer to chpt. [20.9 Messages due to calibration or simulation](#).

## 16.16 Setting the linearity value of the density factor

To enter a linearity value for the density factor, do the following:

- Select the device in the navigation area.
- **SAW sensor**
- **Maintenance**
- **Calibration** ----->
- **Add. meas. values** ----->
- **Density factor** ----->
- **Linearity** ----->
- **Enter value** ----->
- Set the value of the linearity.
- **Finish**.
- ✓ The linearity value of the density factor is set.

## 16.17 Setting the offset value of the acoustic transmission factor

Instead of setting the offset value of the acoustic transmission factor, you can calibrate it. See chpt. [16.18](#).

To enter an offset value for the acoustic transmission factor, do the following:

- Select the device in the navigation area.
- **SAW sensor**
- **Maintenance**
- **Calibration** ----->
- **Add. meas. values** ----->
- **Acoustic transmission factor** ----->
- **Offset** ----->
- **Enter value** ----->
- Set the value of the offset.
- **Finish**.
- ✓ The offset value of the acoustic transmission factor is set.

## 16.18 Calibrating the offset value of the acoustic transmission factor

- Make sure the teach-in conditions are similar to those of the process.
- In order that the calibration result is correct, make sure the following conditions are met during the teach-in procedure:
  - The liquid temperature is stable
  - The liquid that flows through the device does not change. Or the liquid is still and the pipe is full and free of bubbles.



During the calibration:

- The status indicator is orange, if the operating mode of the status indicator is set to NAMUR (ex-works setting, see chpt. [11.4 Changing the operating mode of the status indicator or switching off the status indicator](#)).
- The NAMUR mode "function check" is active. The outputs react depending on your settings.

Instead of calibrating the offset value of the acoustic transmission factor, you can directly set it. See chpt. [16.17](#).

To calibrate the offset value of the acoustic transmission factor, do the following:

- Make sure the liquid in the pipe is the liquid to be measured.
- Charge the pipe. To avoid bubbles and air in the pipe, make sure it is full of liquid.
- Select the device in the navigation area.
- **SAW sensor**
- **Maintenance**
- **Calibration** -----▶
- **Add. meas. values** -----▶
- **Acoustic transmission factor** -----▶
- **Offset** -----▶
- **Teach-in by reference** -----▶

The current settings are displayed.

- Start the calibration of the offset value.
- After 30 s, enter the acoustic transmission factor of the reference liquid. -----▶

The new settings are displayed.

- **Finish**.

✓ The offset value of the acoustic transmission factor is calibrated.

If the calibration fails, a message is displayed. Refer to chpt. [20.9 Messages due to calibration or simulation](#).

## 16.19 Setting the linearity value of the acoustic transmission factor

To enter a linearity value for the acoustic transmission factor, do the following:

- Select the device in the navigation area.
- **SAW sensor**
- **Maintenance**
- **Calibration** ----->
- **Add. meas. values** ----->
- **Acoustic transmission factor** ----->
- **Linearity** ----->
- **Enter value** ----->
- Set the value of the linearity.
- **Finish**
- ✓ The linearity value of the acoustic transmission factor is set.

## 16.20 Resetting all the calibration data to the default values (additional measurement values)

The calibration data that can be reset is:

- the offset value of the density factor
- the linearity value of the density factor
- the offset value of the acoustic transmission factor
- the linearity value of the acoustic transmission factor

To reset all the calibration data to the default values, do the following:

- Select the device in the navigation area.
- **SAW sensor**
- **Maintenance**
- **Calibration** ----->
- **Add. meas. values** ----->
- **Reset to default** ----->
- **Finish**.
- ✓ All the calibration data is reset to the default values.

## 16.21 Checking the correct behaviour of the device

The feature allows you to check if the device has the expected behaviour depending on the settings you have made.

You can check the behaviour of the device:

- by simulating one or several process values
- by simulating one or several events

### 16.21.1 Selecting the process values to be simulated



The cut-off feature is not checked when simulating a flow rate value.

To check the behaviour by simulating a process value, do the following:

- Select the device in the navigation area.
- **SAW sensor**
- **Maintenance**
- **Simulation** ----->
- **Meas. values** ----->
- **Process value** ----->
- Select one or several process values
- **Values to simulate** ----->

The previously selected process values are displayed.

- Select a process value.
- Enter the value to be simulated
- **Apply**

The status of the simulation is automatically set to **Running** and the value is being simulated.

- Check if the device behaves depending on the settings you have made.

The simulation is active as long as the status **Running** is active. Thus, you can:

- leave the menu to check if a measurement view shows the simulated value or if the analogue output associated to one of the simulated physical quantities gives out the correct current value (see chpt 18.2)\*)
  - or simulate another value for the same process value and/or another process value
  - or simulate one or several events
- To stop the simulation, see chpt. [16.21.3 Stopping the simulation of process values and events](#).

\*) Only variant with outputs.

## 16.21.2 Checking the behaviour of the device by simulating an event



The events **Low flow cut off** and **Backward flow** can only be tested by simulating a flow rate value. See chpt. [16.21.1](#).

To check the behaviour by simulating one or several events that are enabled on the device, do the following:

- Select the device in the navigation area.
- **SAW sensor**
- **Maintenance**
- **Simulation** -----▶
- **Status** -----▶
- Select **Running**
- **Diag. events** \*)-----▶
- Select **Process** or **Electronic** or **Sensor** -----▶
- Select the events to be simulated -----▶
- Check if the device behaves depending on the settings you have made.

The simulation is active as long as the status **Running** is active. Thus, you can:

- leave the menu to check if the simulated events have been generated (see chpt. [15.8 Reading out the diagnostics events that occurred in the process](#), [15.9 Reading out the diagnostics events that occurred on the electronics](#) und [15.10 Reading out the diagnostics events that occurred on the sensor](#))
- or simulate one or several events
- To stop the simulation, see chpt. [16.21.3 Stopping the simulation of process values and events](#).

---

\*) Only appears if at least 1 diag. event is set. Event is set.

## 16.21.3 Stopping the simulation of process values and events

To stop the simulation of process values and events, do the following:

- Select the device in the navigation area.
- **SAW sensor**
- **Maintenance**
- **Simulation** -----▶
- **Status** -----▶
- Select **Stopped** -----▶

✔ The simulation is stopped.



# 17 OUTPUTS - PARAMETER

Chapter only valid for variants with outputs.



The output parameters can be set with the **installer** user level.

## 17.1 Default settings

You can find the default settings of the device in the CANopen supplement for the Type 8098 at [www.burkert.com](http://www.burkert.com)

→ Before making any change in the settings, use the Bürkert Communicator software to print a pdf file with all the default settings of the device.

## 17.2 Changing the type of an output

By default, the outputs are configured as an analogue output. It can be configured as a digital output.

By default settings, the outputs are configured as follows:

Output	Configuration	Designation	Internal designation (Communicator)	Mode
Output 1	Digital	DO1	Output 2 (connected to first output)	Flow (Pulse)
Output 2	Analogue	AO2	Output 3 (connected to second output)	Temperature

Possible configurations of the outputs:

Output	Configuration	Designation	Internal designation (Communicator)
Output 1	Digital	DO1	Output 2 (connected to first output)
	Analogue	AO1	Output 1
Output 2	Analogue	AO2	Output 3 (connected to second output)
	Digital	DO2	Output 3 (connected to second output)

To change the type of the output, do the following:

→ Select the device in the navigation area.

→ **Outputs**

→ **Parameter**

→ **Output x type** ----->

→ Select the type of the output.

✓ The type of the output is changed.

## 17.3 Setting the parameters of an analogue output

By default, the device has 1 digital output and 1 analogue output, **Output 1:digital** and **Output 3:analog**. You can change the type of the outputs: see chpt. 17.2.

The following parameters can be set:

- the **process value** associated to the analogue output.
- the value of the process variable, which is associated to the 4 mA current of the analogue output.
- the value of the process variable, which is associated to the 20 mA current of the analogue output.
- the **damping** level of the values that are transmitted on the analogue output. By default, the values transmitted on the analogue output are not damped.
- the behaviour of the analogue output depending on the status of the device.

Parameter	Default setting
<b>Process value</b> associated to the analogue output	<b>Volume flow rate</b>
<b>4 mA value</b>	<b>0.0 l/min</b>
<b>20 mA value</b>	Full scale of the flow rate measurement range. Value depends on the DN of the process connections.
<b>Damping</b> level	<b>None</b>
Behaviour if a <b>Failure</b> message is generated by the device	<b>22mA</b>
Behaviour if an <b>Out of spec.</b> message is generated by the device	<b>Continue</b>
Behaviour if a <b>Maintenance req.</b> message is generated by the device	<b>Continue</b>

Table 21: Default parameters of the 2 analogue outputs

### 17.3.1 Changing the process value and the process value range associated to an analogue output

To change the process value and the process value range associated to an analogue output, do the following:

- Select the device in the navigation area.
- **Outputs**
- **Parameter**
- **Output 1: analog** or **Output 3: analog** ----->
- **Settings** ----->

The current settings are displayed.

- Select a process value ----->
- Set the value associated to a 4 mA current ----->
- Set the value associated to a 20 mA current ----->

The new settings are displayed.

- **Finish**

✓ The process value and the process value range associated to the analogue output are changed.

### 17.3.2 Selecting the damping level of the values transmitted on an analogue output

The following diagram shows the effect of the damping on the flow rate measurements.

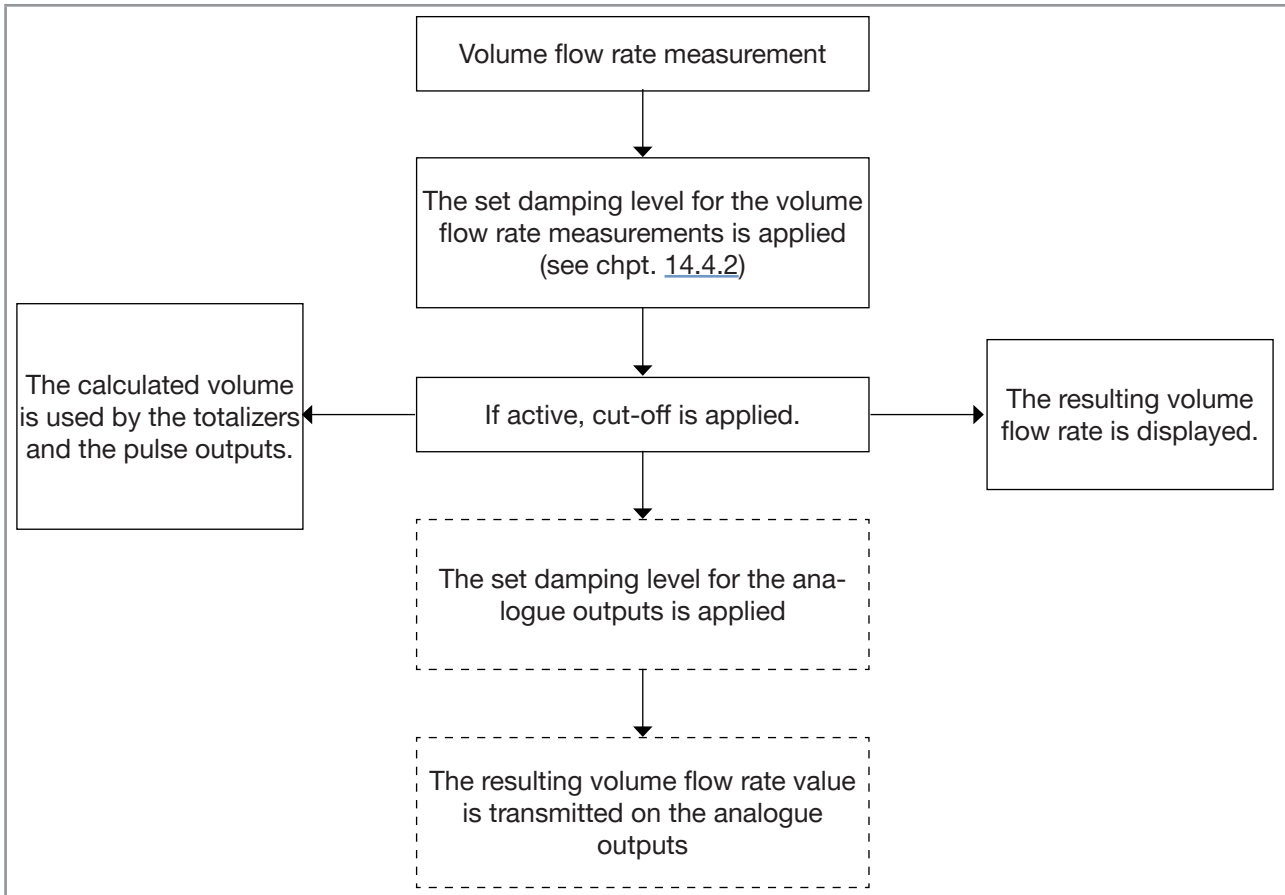

Figure 33: Effect of the damping on the flow rate measurements



When the damping is active (i.e. when a **Low**, **Medium** or **High** level has been set) and the values vary for  $\pm 30\%$  (for example when charging the pipe or stopping the flow), the damping is not applied to the new measured value.

Damping level	Response time
None	< 1 s
Low	1 s
Medium	10 s
High	30 s

Table 22: Response times (10% – 90%) of the damping levels

To change the damping level of the values transmitted on an analogue output, do the following:

- Select the device in the navigation area.
- **Outputs**
- **Parameter**
- **Output 1: analog** or **Output 3: analog** ----->
- **Damping** ----->
- Select the damping level.
- ✔ The damping level is changed.

### 17.3.3 Configuring the behaviour of an analogue output depending on the status of the device

Depending on the status of the device, the analogue output:

- can continue to transmit the process values.
- or, can transmit and hold the last process value (not available if measurements are not possible)
- or, can transmit a 22 mA current (not available if measurements are not possible)
- or, can transmit a 3.6 mA current (not available if measurements are not possible)
- or, can transmit any preset current value (i.e. a **Forced value**).

To change the behaviour of an analogue output depending on the status of the device, do the following:

- Select the device in the navigation area.
- **Outputs**
- **Parameter**
- **Output 1: analog** or **Output 3: analog** ----->
- **Behaviour** ----->
- Select **Measurement value not ascertainable**, **Failure**, **Out of specification** or **Maintenance required** ----->

The current behaviour is displayed.

- Select the behaviour associated to the device status.
- If the behaviour is set to **Forced value**, set the current value to any value in the range 3.5 – 23 mA.
- ✔ The behaviour of an analogue output is changed.

## 17.4 Disabling an analogue output

If an analogue output is not wired, the analogue output can be disabled to avoid the generation of the events **Output 1, open loop** or **Output 2, open loop**.

To disable an analogue output, do the following:

- Select the device in the navigation area.
- **Outputs**
- **Parameter**
- **Output 1: analog** or **Output 3: analog** ----->
- **Disabled**

- ✓ The analogue output is disabled.
- ✓ The menus related to the analogue output are not displayed any more.

## 17.5 Setting the parameters of a digital output

By default, the device has 1 digital output and 1 analogue output, **Output 1:digital** and **Output 3:analog**. You can change the type of the outputs: see chpt. [17.2](#).

A digital output can be configured:

- as an on/off output
- or, to switch depending on two threshold values
- or, as a frequency output
- or, as a pulse output

Default parameters of output 1 after activation as digital output:

Parameter	Default value	Process connections
<b>Mode</b>	<b>Pulse</b>	all
<b>Max. pulse time</b>	65 ms	all
<b>Max. frequency</b>	2000 Hz	all
<b>Pulse mode</b>	<b>Pulses/volume</b>	all
<b>Pulses/volume</b>	4000 pulses per volume unit	3/8" ASME
	2000 pulses per volume unit	1/2" ASME
		DN08 ISO
	500 pulses per volume unit	ASME 3/4"
		DN15 DIN
		DN15 ISO
	250 pulses per volume unit	ASME 1"
		DN25 DIN
		DN25 ISO
	100 pulses per volume unit	ASME 1 1/2"
		DN40 DIN
		DN40 ISO
ASME 2"		
60 pulses per volume unit	SMS 50	
	DN50 DIN	
	DN50 ISO	
	ASME 2 1/2"	
40 pulses per volume unit	DN65 DIN	
	DN65 ISO	
	ASME 3"	
30 pulses per volume unit	DN80 DIN	
	DN80 ISO	
<b>Inverted</b>	<b>No</b>	all

Table 23: Default parameters of the digital output

Default parameters of output 3 after activation as digital output:

Parameter	Default value
<b>Mode</b>	<b>On/Off</b>
<b>Inverted</b>	<b>No</b>
<b>Delay</b>	0.000 s

Table 24: Default parameters of the digital output

## 17.5.1 Configuring a digital output as an on/off output

An on/off output switches every time the associated event is generated.

You can select between the following events:

- **Failure**
- **Function check**
- **Out of specification**
- **Maintenance required**
- any event activated in the menu **SAW sensor - Parameter - Diagnostics - Process**
- any event activated in the menu **SAW sensor - Parameter - Diagnostics - Electronic**

To configure a digital output as an on/off output, do the following:

- Select the device in the navigation area.
- **Outputs**
- **Parameter**
- **Output 2:digital** or **Output 3:digital** ----->
- **Mode** ----->
- Select **On/Off** ----->
- **Settings** ----->

The current settings are displayed.

- Select the events ----->
- Select to invert the switching or not (see [Figure 34](#) and [Figure 35](#)) ----->
- Set the value of the switching time delay ----->

The new settings are displayed.

- **Finish**

✓ The digital output is configured as an on/off output.

## 17.5.2 Configuring a digital output as an output with switching thresholds

An output with switching thresholds switches depending on two threshold process values. The output can switch either according to an hysteresis model or according to a window model.

### Hysteresis switching

The output status changes when a threshold is reached:

- by increasing values, the output state changes when the high threshold  $X_+$  is reached.
- by decreasing values, the output state changes when the low threshold  $X_-$  is reached.



$X_-$  = low switching threshold  
 $X_+$  = high switching threshold

Figure 34: Hysteresis switching

**Window switching:** the output state changes as soon as any threshold ( $X_-$  or  $X_+$ ) is reached.

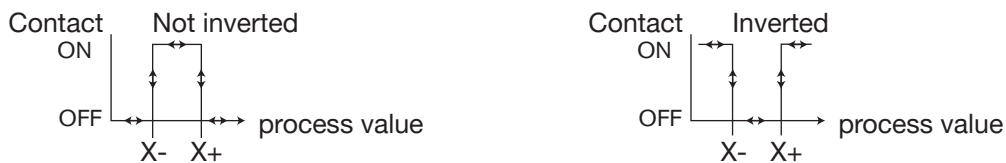

$X_-$  = low switching threshold  
 $X_+$  = high switching threshold

Figure 35: Window switching

To configure a digital output as an output with switching thresholds, do the following:

- Select the device in the navigation area.
- **Outputs**
- **Parameter**
- **Output 2:digital** or **Output 3:digital** ----->
- **Mode** ----->
- Select **Threshold**
- **Settings** ----->

The current settings are displayed.

- Select the process value associated to the digital output ----->
- Select the **hysteresis** switching or the **window** switching of the digital output ----->





If the high threshold is equal to the low threshold, the digital output is deactivated.

- Set the value of the high threshold ----->
- Set the value of the low threshold ----->
- Select to invert the switching or not ----->
- Set the value of the switching time delay ----->

The new settings are displayed.

→ **Finish**

✔ The digital output is configured to switch depending on 2 threshold values.

### 17.5.3 Configuring a digital output as a frequency output

A frequency output transmits a frequency signal which is proportional to the chosen process value.

To configure a digital output as a frequency output, do the following:

- Select the device in the navigation area.
- **Outputs**
- **Parameter**
- **Output 2:digital** or **Output 3:digital** ----->
- **Mode** ----->
- Select **Frequency**
- **Settings** ----->

The current settings are displayed.

- Select the process value associated to the digital output ----->



If the high value is equal to the low value, the digital output is deactivated.

- Set the high value of the frequency range ----->
- Set the process value which is associated to the high value of the frequency range ----->
- Set the low value of the frequency range ----->
- Set the process value which is associated to the low value of the frequency range ----->

The new settings are displayed.

→ **Finish**

✔ The digital output is configured as a frequency output.

## 17.5.4 Configuring a digital output as a pulse output

When the digital output is configured as a pulse output, it transmits:

- either a number of pulses proportional to the measured volume (**pulse/volume**),
- or 1 pulse each time a set volume of liquid has been measured by the device (**volume/pulse**).



The number of pulses that can be given out by a pulse output of the device is max. 2000 per second.

By default, the value of the parameter **pulse/volume** is set for the full scale of the flow-rate measurement range. Observe the following rules to adapt the value of the parameter **pulse/volume** to your flow-rate measurement range:

- Make sure that the maximum flow rate value (in litres per second) multiplied by the pulse per litre value is lower than 2000 pulses per second. Pulses above the 2000 pulses/s limit are not transmitted immediately but are accumulated. The accumulated pulses are transmitted as a block when the 2000 pulses/s limit is no longer exceeded.
- The pulse output of the device is connected to an input of another equipment, for example a PLC. Take into account the frequency of the input, because it can be lower than the maximum pulse frequency that you have set.



Calculation example for the number of pulses per volume:

Consider a device with DN40 ISO process connections. The following device data are needed:

- Maximum measurable flow-rate at a liquid velocity of 10 m/s: 925 L/min  
→ Read the maximum flow-rate value in **Outputs** -----> **Parameter** -----> **Output 1: analog** or **Output 3: analog** -----> **Settings** -----> **Current settings** -----> **20 mA value** or on the test report that is delivered with the device.

- default number of pulses per volume unit: 100 pulses/volume unit

Data for your application with a maximum measurable flow-rate of 400 L/min = 6.6 L/s

- number of pulses per volume unit with a safety margin of 5%, in order to not exceed 2000 Hz:  
 $(2000 - 5\% \times 2000) / 6.6 \text{ L/s} = 287 \text{ pulses/litre}$

To configure a digital output as a pulse output, do the following:

- Select the device in the navigation area.
- **Outputs**
- **Parameter**
- **Output 2:digital** or **Output 3:digital** ----->
- **Mode** ----->
- Select **Pulse**
- **Settings** ----->

The current settings are displayed.

- **Counted volume** ----->
- Set the value of the maximum duration of a pulse ----->
- Set the value of the maximum frequency for the transmission of the pulses ----->

- Select pulse/volume or volume/pulse in the wanted volume units -----▶
- If you have selected pulse/volume, set the number of pulses to be transmitted on the digital output for either 1 litre or 1 US gallon or 1 imperial gallon. Enter a number of pulses that is higher than 1. If you enter a number of pulses that is lower than 1, the display resolution is not optimum. -----▶
- If you have selected volume/pulse, set the volume of liquid for which 1 pulse is transmitted on the digital output -----▶
- Select to invert the signal or not -----▶
- Select the counting direction -----▶

The new settings are displayed.

→ **Finish**

- ✔ The digital output is configured as a pulse output.

## 17.6 Resetting all the parameters of an output to default values

To reset all the parameters of an output to the default values, do the following:

- Select the device in the navigation area.
- **Outputs**
- **Parameter**
- Select an output -----▶
- **Reset to default** -----▶
- **Finish**

- ✔ All the parameters of the output are reset.

## 17.7 Resetting all the parameters of all the outputs to the default values

To reset all the parameters of all the outputs to the default values, do the following:

- Select the device in the navigation area.
- **Outputs**
- **Parameter**
- **Reset to default** -----▶
- **Finish**

- ✔ All the parameters of all outputs are reset.

## 18 OUTPUTS - DIAGNOSTICS

Chapter only valid for variants with outputs.

### 18.1 Analogue output: reading out the current status and the values of the current

Any user can read out the following data related to an analogue output:

- the current status of the analogue output, i.e. **OK**, **Open loop** or **Impedance too high**.
- the value of the current related to the measured quantity of the process value,
- the value of the current transmitted on the analogue output.

This data is in read-only mode. To read out some data related to an analogue output, do the following:

→ Select the device in the navigation area.

→ **Outputs**

→ **Diagnostics**

→ Select the analogue output -----▶

✔ The data related to the analogue output are displayed.

### 18.2 Digital output: reading out the mode, the current status and the current value

Any user can read out the following data related to a digital output:

- the current mode, e.g. **pulse**, of the digital output,
- the current status of the digital output, i.e. **OK** or **Overload**.
- the current value of the digital output, e.g. for a pulse output, the number of pulses transmitted on the output.

This data is in read-only mode. To read out some data related to a digital output, do the following:

→ Select the device in the navigation area.

→ **Outputs**

→ **Diagnostics**

→ Select the digital output -----▶

✔ The data related to the digital output are displayed.

## 19 OUTPUTS - MAINTENANCE

Chapter only valid for variants with outputs.



The settings can be made with the **installer** user level.

### 19.1 Calibrating an analogue output

The analogue outputs are calibrated at the factory.

To adjust the analogue output to your equipment, do the following:

- Connect a multimeter to the analogue output you want to adjust.
- Select the device in the navigation area.
- **Outputs**
- **Maintenance**
- **Output 1: analog** or **Output 3: analog** ----->
- **Calibration** ----->

The current settings are displayed.

The device generates a 4 mA current on the selected analogue output.

- Enter the current value measured by the multimeter ----->

The device generates a 20 mA current on the selected analogue output.

- Enter the current value measured by the multimeter ----->

The new settings are displayed.

- **Finish**

✔ The analogue output is adjusted.

## 19.2 Checking the correct operation of an analogue output

To check the correct operation of an analogue output, do the following:

- Connect a multimeter to the analogue output you have adjusted.
- Select the device in the navigation area.
- **Outputs**
- **Maintenance**
- **Output 1: analog** or **Output 3: analog** ----->
- **Test** ----->
- Enter the current value to be tested ----->

The device generates the entered current value on the selected analogue output.

- Check the value on the multimeter.
- **Finish**

## 19.3 Resetting the calibration data of an analogue output to the default values

To reset the calibration data of an analogue output to its default values, do the following:

- Select the device in the navigation area.
- **Outputs**
- **Maintenance**
- **Output 1: analog** or **Output 3: analog** ----->
- **Reset to default** ----->
- **Finish**

✓ The calibration data of an analogue output is reset to the default values.

## 19.4 Resetting the calibration data of all the analogue outputs to the default values

To reset the calibration data of all the analogue outputs to its default values, do the following:

→ Select the device in the navigation area.

→ **Outputs**

→ **Maintenance**

→ **Reset to default** ----->

→ **Finish**

✓ The calibration data of all the analogue outputs is reset to its default values.

## 19.5 Checking the correct operation of an on/off output or a threshold output

To check the correct operation of a digital output configured as an on/off output, do the following:

→ Connect a multimeter to the digital output configured as an on/off output.

→ Energize the output.

→ Select the device in the navigation area.

→ **Outputs**

→ **Maintenance**

→ **Output 2: digital** or **Output 3: digital**, configured as an on/off output or as a threshold output ----->

→ **Test** ----->

→ Select **On** or **Off** ----->

→ Check if the output is operating correctly.

→ **Finish**

## 19.6 Checking the correct operation of a frequency output

To check the correct operation of a digital output configured as a frequency output, do the following:

- Connect a frequency meter to the digital output configured as a frequency output.
- Energize the output.
- Select the device in the navigation area.
- **Outputs**
- **Maintenance**
- **Output 2: digital** or **Output 3: digital**, configured as a frequency output -----▶
- **Test** -----▶
- Enter a frequency value -----▶
- Check if the output is operating correctly.
- **Finish**

## 19.7 Checking the correct operation of a pulse output

To check the correct operation of a digital output configured as a pulse output, do the following:

- Connect a counter to the digital output configured as a pulse output.
- Energize the output.
- Select the device in the navigation area.
- **Outputs**
- **Maintenance**
- **Output 2: digital** or **Output 3: digital**, configured as a pulse output -----▶
- **Test** -----▶
- Enter a frequency value -----▶
- Enter a number of pulses -----▶
- Check if the output is operating correctly.
- **Finish**



## 20 MAINTENANCE AND TROUBLESHOOTING

### 20.1 Safety instructions



#### Risk of injury due to electrical voltage.

- ▶ Before carrying out work on the system, disconnect the electrical power for all the conductors and isolate it.
- ▶ According to UL/EN 61010-1:
  - Double isolate all devices connected to the flow meter Type 8098 from the mains and note that these are limited energy circuits for all circuits connected to the flow meter Type 8098.
- ▶ Observe all applicable accident protection and safety regulations for electrical equipment.

#### Risk of injury due to high pressure in the installation.

- ▶ Before any intervention in the installation, stop the circulation of fluid, cut off the pressure and drain the pipe.
- ▶ Before any intervention in the installation, make sure there is no pressure in the pipe.
- ▶ Observe the dependency between the fluid temperature and the fluid pressure for the fitting used.

#### If switched on for a prolonged time, risk of burns or fire due to hot device surfaces

- ▶ Do not touch with bare hands.
- ▶ Keep the device away from highly flammable substances and fluids.

#### Risk of burns due to high fluid temperatures.

- ▶ Do not touch with bare hands the parts of the device that are in contact with the fluid.
- ▶ Use safety gloves to handle the device.
- ▶ Before opening the pipe, stop the circulation of fluid and drain the pipe.
- ▶ Before opening the pipe, make sure the pipe is completely empty.

#### Risk of injury due to the nature of the fluid.

- ▶ Respect the prevailing regulations on accident prevention and safety relating to the use of dangerous fluids.



### WARNING

#### Risk of injury due to non-conforming maintenance.

- ▶ Maintenance must only be carried out by qualified and skilled staff with the appropriate tools.
- ▶ Ensure that the restart of the installation is controlled after any interventions.



### CAUTION

#### Risk of injury due to a heavy device.

A heavy device can fall down during transport or during installation and cause injuries.

- ▶ Transport, install and dismantle a heavy device with the help of another person.
- ▶ Use appropriate tools.

## 20.2 Information on returning the device to the manufacturer or to the reseller

- To return the device for calibration or any after sales service, use the original packaging.
- Send the device back to your local Bürkert sales office. The addresses of our international sales offices are available on the internet at [www.burkert.com](http://www.burkert.com)

## 20.3 Cleaning the outer surface of the device



→ Always use a cleaning agent compatible with the materials from which the device is made.

The outer surface device can be cleaned with a cloth slightly dampened water or with a detergent compatible with the materials the device is made of.

Please feel free to contact your Bürkert supplier for any additional information.

## 20.4 Cleaning In Place (CIP) of the device

The measurement tube of the device can be cleaned in place in all the applications the device is used in.

- Do the cleaning in place procedure at appropriate intervals to prevent malfunctions or contamination.

### NOTICE

**The device and the seals used on the process connections can be damaged by the cleaning agents or the disinfecting agents.**

- ▶ Use cleaning agents or disinfecting agents with a concentration that is compatible with the material the measurement tube is made of.
- ▶ Check the chemical compatibility of the cleaning agents or disinfecting agents with the materials of the seals used on the process connections.
- ▶ For more information on the chemical compatibility and the cleaning temperatures contact your local Bürkert sales office.
- ▶ Obey the cleaning in place procedure that is suited for your application.

Procedure for the cleaning in place of the device:

- Rinse the measurement tube with water of the best quality available in the factory (ideally, water for injection or purified water) under the following conditions:
  - at a temperature between 50 °C and 75 °C,
  - at a flow velocity between 1.5 m/s and 2.1 m/s,
  - for a duration that is determined by your CIP recipe.
- Prepare one or two cleaning agents at concentrations and with chemical properties that have proven their effectiveness on the residues to be removed. Make sure the concentration of the cleaning agent does not damage stainless steel 316L.
- Let the cleaning agent circulate through the measurement tube under the following conditions:
  - at a temperature between 50 °C and 75 °C,

- at a flow velocity between 1.5 m/s and 2.1 m/s,
  - for a duration that is determined by your CIP recipe.
- Rinse the measurement tube with water of the best quality available in the factory (ideally, water for injection or purified water) under the same conditions as the first rinse.
- If needed, let a second cleaning agent circulate through the measurement tube, under the same conditions as the first cleaning agent, to neutralize any alkaline residues that remain.
- Do a final rinse of the measurement tube, under the same conditions as the first two rinses. Monitor the conductivity value of the final rinse to make sure all the cleaning agents have been removed.
- Blow air through the measurement tube to remove moisture and to ensure maintenance of a good passive layer.
- If needed, do a de-scaling by letting a solution made of water, nitric acid  $\text{HNO}_3$  [15 – 20%] and hydrofluoric acid HF [2 – 5%] at a temperature between 20 °C and 60 °C circulate through the measurement tube for 5 – 30 minutes.
- After a de-scaling, or to prevent any corrosion effects after 1 or more (depending on the application) CIP-procedures, do a passivation by letting a solution made of water and nitric acid  $\text{HNO}_3$  [3 – 5%] at a temperature between 70 °C and 80 °C circulate through the measurement tube for the same duration as the CIP-procedure. Then, rinse the measurement tube with water with the best quality available in the factory (ideally, water for injection or purified water) under the same conditions as the other rinses.
- Blow air through the measurement tube to remove moisture and to ensure creation of a uniform passive layer.

## 20.5 Sterilisation In Place (SIP) of the device

The measurement tube of the device can be sterilised in place in all the applications the device is used in.

- Do the sterilisation in place procedure using dry saturated steam at a temperature between 121 °C and 140 °C for max. 1 hour.

## 20.6 Troubleshooting when a message is displayed

→ If the message displayed on your device is not explained in the Operating Instructions, contact Bürkert.

If a message has been generated:

- a symbol is displayed in the information bar: see [Table 25](#).
- Ex works and if the status indicator is not switched off (see [chpt. 11.4.2 Switching off the status indicator](#)), the status indicator changes its colour and state based on the NAMUR NE 107 recommendation: see [chpt. 5.6](#).
- The message is displayed in a list called **logbook**. The list can be accessed in the Bürkert Communicator.





Symbol	Status	Description
	Failure, error or fault	<ul style="list-style-type: none"> <li>• Malfunction,</li> <li>• or monitored values in the error range.</li> </ul>
	Function check	Ongoing work on the device (for example, checking the correct behaviour of the outputs by simulating measurement values); the output signal is temporarily invalid (e.g. frozen).
	Out of specification	<p>The ambient conditions or process conditions for the device are outside the permitted ranges.</p> <p>Device internal diagnostics point to problems in the device or with the process properties.</p>
	Maintenance required	<p>The device is in controlled operation; however, the function is briefly restricted.</p> <p>→ Do the required maintenance operation.</p>

Table 25: Device status symbols

## 20.7 Messages when setting wrong parameters

### 20.7.1 Kinematic viscosity $\leq 0$ . Check the flow viscosity compensation's parameters

Message	Kinematic viscosity $\leq 0$ . Check the flow viscosity compensation's parameters
Symbol displayed	
Possible cause	<ul style="list-style-type: none"> <li>• When activating the compensation for a liquid with a constant viscosity, you have entered a negative value of the viscosity. See chpt. <a href="#">14.11.2</a></li> <li>• When activating the compensation for a liquid with a non-constant viscosity, the result of the entered equation is negative or equal to 0. See chpt. <a href="#">14.11.3</a>, <a href="#">14.11.4</a>, <a href="#">14.11.5</a>.</li> </ul>
What to do?	<p>→ When activating the compensation for a liquid with a constant viscosity, enter a positive value of the viscosity.</p> <p>→ When activating the compensation for a liquid with a non-constant viscosity, make sure the fluid temperature is in the range covered by the equation.</p> <p>→ When activating the compensation for a liquid with a non-constant viscosity, make sure you have entered correct constant values.</p>

## 20.8 Messages due to device internal diagnostics

### 20.8.1 Message "Overvoltage detected"

Message	Overvoltage detected
Symbol displayed	
Possible cause	The supply voltage of the device is higher than or equal to the permitted maximum error value. See chpt. <a href="#">11.7 Monitoring the device supply voltage or the device temperature</a> .
What to do?	<p>→ Energize the device with a 12 – 35 V DC voltage.</p> <p>As soon as the supply voltage value returns to within the permitted range, the error is automatically reset.</p>

### 20.8.2 Message "Undervoltage detected"

Message	Undervoltage detected
Symbol displayed	
Possible cause	The supply voltage of the device is lower than or equal to the permitted minimum error value. See <a href="#">chpt. 11.7 Monitoring the device supply voltage or the device temperature.</a>
What to do?	→ Energize the device with a 12 – 35 V DC voltage.  As soon as the supply voltage value returns to within the permitted range, the error is automatically reset.

### 20.8.3 Message "Voltage is above the warning limit"

Message	Voltage is above the warning limit
Symbol displayed	
Possible cause	The supply voltage of the device is higher than or equal to the permitted maximum warning value set in <a href="#">chpt. 11.7.2 Changing the 2 warning limit values.</a>
What to do?	→ Energize the device with a 12 – 35 V DC voltage.  As soon as the supply voltage value returns to within the permitted range, the warning is automatically reset.

### 20.8.4 Message "Voltage is below the warning limit"

Message	Voltage is below the warning limit
Symbol displayed	
Possible cause	The supply voltage of the device is lower than or equal to the permitted minimum warning value plus the hysteresis value, both set in <a href="#">chpt. 11.7.2 Changing the 2 warning limit values.</a>
What to do?	→ Energize the device with a 12 – 35 V DC voltage.  → If needed, change the limit value set in <a href="#">chpt. 11.7.2 Changing the 2 warning limit values.</a>  As soon as the supply voltage value returns to within the permitted range, the warning is automatically reset.

### 20.8.5 Message "Battery voltage is below the warning limit"

Message	Battery voltage is below the warning limit
Symbol displayed	
Possible cause	The voltage of the battery is under the low limit value. See chpt. <a href="#">11.8</a> . The battery allows the internal clock to run for 7 days at ambient temperature when the power supply of the device is switched off or too low.
What to do?	→ Energize the device with a 12 – 35 V DC voltage to load the battery. As soon as the battery voltage value returns to within the permitted range, the warning is automatically reset.

### 20.8.6 Message "bùS event: bus connection lost / not available"

Message	bùS event: bus connection lost / not available
Symbol displayed	
Possible cause	The device is configured to send the measured process data to bùS or to a CANopen fieldbus but does not find any other network participant.
What to do?	→ Set the <b>Bus mode</b> to <b>Standalone</b> . See chpt. <a href="#">11.6.7</a> .

### 20.8.7 Message "Overtemperature detected"

Message	Overtemperature detected
Symbol displayed	
Possible cause	The internal temperature of the device is higher than the permitted maximum error value (+85 °C). See chpt. <a href="#">11.7 Monitoring the device supply voltage or the device temperature</a> .
What to do?	→ Make sure the internal temperature of the device is less than +85 °C. As soon as the internal temperature value returns to within the permitted range, the error is automatically reset.

### 20.8.8 Message "Undertemperature detected"

Message	Undertemperature detected
Symbol displayed	
Possible cause	The internal temperature of the device is lower than the permitted minimum error value (–40 °C). See chpt. <a href="#">11.7 Monitoring the device supply voltage or the device temperature</a> .
What to do?	→ Make sure the internal temperature of the device is higher than –40 °C.  As soon as the internal temperature value returns to within the permitted range, the error is automatically reset.

### 20.8.9 Message "Temperature is above the warning limit"

Message	Temperature is above the warning limit
Symbol displayed	
Possible cause	The internal temperature of the device is higher than the permitted maximum warning value set in chpt. <a href="#">11.7.2 Changing the 2 warning limit values</a> .
What to do?	→ Make sure the internal temperature of the device is less than the maximum warning value.  As soon as the internal temperature value returns to within the permitted range, the error is automatically reset.

### 20.8.10 Message "Temperature is below the warning limit"

Message	Temperature is below the warning limit
Symbol displayed	
Possible cause	The internal temperature of the device is lower than the permitted minimum warning value set in chpt. <a href="#">11.7.2 Changing the 2 warning limit values</a> .
What to do?	→ Make sure the internal temperature of the device is higher than the minimum warning value.  As soon as the internal temperature value returns to within the permitted range, the error is automatically reset.



### 20.8.11 Message "Internal message store overflow"

Message	Internal message store overflow
Symbol displayed	
Possible cause	The number of messages generated by the device is higher than the memory capacity.
What to do?	→ Make sure the limits set for the monitoring of the process values are correct.

### 20.8.12 Message "No signals from interdigital transducer"

Message	No signals from interdigital transducer
Symbol displayed	-
Possible cause	The sensor is not operating correctly.
What to do?	→ Send the complete device back to Bürkert because the sensor must be replaced.

### 20.8.13 Message "No temperature sensor detected"

Message	No temperature sensor detected
Symbol displayed	
Possible cause	The temperature of the liquid can neither be measured nor compensated.
What to do?	→ If the temperature of the liquid must be measured, send the complete device back to Bürkert because the sensor must be replaced.

### 20.8.14 Message "Pipe characteristics have changed: check limits values"

Message	Pipe characteristics have changed: check limits values
Symbol displayed	 (symbol changed)
Possible cause	The transmitter has been associated with another sensor.
What to do?	→ Make sure all the settings related to the flow rate measurement are still correct.

### 20.8.15 Message "Measure board is in boot starter mode, no firmware found n°1"

Message	Measure board is in boot starter mode, no firmware found n°1
Symbol displayed	
Possible cause	The firmware of the measurement board is lost or is not valid.
What to do?	→ Start the device again. → If the error is still there, send the device back to Bürkert.

### 20.8.16 Message "Data returned by the measurement PCB is invalid n°1"

Message	Data returned by the measurement PCB is invalid n°1
Symbol displayed	-
Possible cause	The device cannot measure the liquid parameters, for example, because there are too many bubbles in the liquid or the sensor tube is not completely filled.
What to do?	→ Make sure there is no problem in the installation.

### 20.8.17 Message "Communication between transmitter PCB and measurement PCB has been interrupted n°x"

Message	Communication between transmitter PCB and measurement PCB has been interrupted n°x
Symbol displayed	
Possible cause	There is no communication between the sensor and the transmitter.
What to do?	→ Make sure the cable connecting the sensor to the transmitter is not broken and correctly plugged in. See chpt. <a href="#">7.2.1 Changing the position of the transmitter on the sensor.</a>

### 20.8.18 Message "The measurement board bootloader operation failed n° 1"

Message	The measurement board bootloader operation failed n° 1
Symbol displayed	
Possible cause	During the firmware update, the sensor software could not be updated.
What to do?	→ Send the device back to Bürkert.

### 20.8.19 Message "An error occurred during communication"

Message	An error occurred during communication
Symbol displayed	
Possible cause	The flat cable that connects the sensor to the transmitter may be damaged.
What to do?	→ Make sure the flat cable is correctly connected. → If the cable is damaged, send the device back to Bürkert.

### 20.8.20 Message "Max. flow rate"

Message	Max. flow rate
Symbol displayed	 (symbol not linked to a user setting)
Possible cause	The maximum flow rate is measured in the pipe. The flow rate in the tube is higher than 10 m/s, whatever the DN of the tube.
What to do?	→ Make sure the flow rate value is less than 10 m/s.

### 20.8.21 Message "Max temperature"

Message	Max temperature
Symbol displayed	 (symbol not linked to a user setting)
Possible cause	The temperature in the tube is higher than 150 °C. The maximum liquid temperature is measured in the pipe.  This message does not depend on the liquid temperature limits set by the user.
What to do?	→ Make sure the liquid temperature is in the permitted range.

### 20.8.22 Message "Totalizer 1 stopped" or "Totalizer 2 stopped"

Message	Totalizer 1 stopped or Totalizer 2 stopped
Symbol displayed	-
Possible cause	The related totalizer has been stopped by the user.
What to do?	→ If needed, start the totalizer again.

### 20.8.23 Message "Totalizer 1 started" or "Totalizer 2 started"

Message	Totalizer 1 started or Totalizer 2 started
Symbol displayed	-
Possible cause	The related totalizer has been started by the user.
What to do?	-

## 20.9 Messages due to calibration or simulation

### 20.9.1 Message "Calibration result out of range"

Message	Calibration result out of range
Symbol displayed	 (symbol changed)
Possible cause	The calibration has failed. The calibration has failed because of 1 of the possible causes: <ul style="list-style-type: none"> <li>• An event such as <b>Change of liquid</b> or <b>Sound cond. out of range</b> has been generated during the calibration.</li> <li>• The calculated offset of the density factor is lower than 0.5 or higher than 2.</li> <li>• The calculated offset of the acoustic transmission factor is lower than 0.5 or higher than 2.</li> </ul>
What to do?	→ Make sure the liquid is the same during the calibration procedure. → Make sure the conditions are met to measure the flow rate correctly. → Do a new calibration.

### 20.9.2 Message "Zero calibration cancelled, the flow rate is higher than 5% of full scale"

Message	Zero calibration cancelled, the flow rate is higher than 5% of full scale
Symbol displayed	
Possible cause	The calibration has failed because the flow rate is less than 5% of the full scale.
What to do?	→ Make sure the flow is stopped in the pipe. → Do a new calibration.

### 20.9.3 Message "Calibration cancelled"

Message	Calibration cancelled
Symbol displayed	
Possible cause	The user has interrupted a calibration of the zero flow, before the waiting time of 30 seconds has elapsed.
What to do?	→ Do a new calibration and observe the given instructions.

### 20.9.4 Message "Calibration cancelled, the flow rate is less than 5% of the full scale"

Message	Calibration cancelled, the flow rate is less than 5% of the full scale
Symbol displayed	
Possible cause	The calibration has failed because the flow rate is less than 5% of the full scale.
What to do?	→ Make sure the flow rate is higher than 5% of the full scale. → Do a new calibration.

### 20.9.5 Message "Resulting K factor is less than 0.8 or higher than 1.2"

Message	Resulting K factor is less than 0.8 or higher than 1.2
Symbol displayed	
Possible cause	When calibrating the K factor by using a teach-in procedure depending on the flow rate or depending on a known volume, you have entered a reference value that varies for $\pm 20\%$ from the measured value.
What to do?	→ Do a new calibration. → Enter a correct reference value.

### 20.9.6 Message "Resulting offset is higher than 10 °C, 18 °F"

Message	Resulting offset is higher than 10 °C, 18 °F
Symbol displayed	
Possible cause	When calibrating the offset value of the liquid temperature, you have entered a reference value that varies for $\pm 10$ °C (18 °F) from the measured value.
What to do?	→ Do a new calibration. → Enter a correct reference value.

### 20.9.7 Message "Test mode activated"

Message	Test mode activated
Symbol displayed	
Possible cause	The test of an output has been started by the user.
What to do?	→ If needed, complete the test.

### 20.9.8 Message "Simulation mode active"

Message	Simulation mode active
Symbol displayed	
Possible cause	A measurement value is being simulated.
What to do?	→ As soon as the simulation is completed, the message is reset.

## 20.10 Messages due to the monitoring of process values

### 20.10.1 Message "Flow rate too high"

Message	Flow rate too high
Symbol displayed	
Possible cause	The flow rate value is higher than the permitted maximum error value set in <a href="#">chpt. 14.4.7 Changing the error limits, the warning limits and the hysteresis of the volume flow rate</a>
What to do?	As soon as the flow rate returns to within the permitted range, the error is automatically reset.

Message	Flow rate too high
Symbol displayed	
Possible cause	The flow rate value is higher than the permitted maximum warning value set in <a href="#">chpt. 14.4.7 Changing the error limits, the warning limits and the hysteresis of the volume flow rate</a>
What to do?	As soon as the flow rate returns to within the permitted range, the warning is automatically reset.

## 20.10.2 Message "Flow rate too low"

Message	Flow rate too low
Symbol displayed	
Possible cause	The flow rate value is lower than the permitted minimum error value set in <a href="#">chpt. 14.4.7 Changing the error limits, the warning limits and the hysteresis of the volume flow rate</a>
What to do?	As soon as the flow rate returns to within the permitted range, the error is automatically reset.

Message	Flow rate too low
Symbol displayed	
Possible cause	The flow rate value is lower than the permitted minimum warning value set in <a href="#">chpt. 14.4.7 Changing the error limits, the warning limits and the hysteresis of the volume flow rate</a>
What to do?	As soon as the flow rate returns to within the permitted range, the warning is automatically reset.

## 20.10.3 Message "Temperature too high"

Message	Temperature too high
Symbol displayed	
Possible cause	The value of the liquid temperature is higher than the permitted maximum error value set in <a href="#">chpt. 14.5.7 Changing the error limits, the warning limits and the hysteresis of the liquid temperature</a> .
What to do?	As soon as the flow rate returns to within the permitted range, the error is automatically reset.

Message	Temperature too high
Symbol displayed	
Possible cause	The value of the liquid temperature is higher than the permitted maximum warning value set in <a href="#">chpt. 14.5.7 Changing the error limits, the warning limits and the hysteresis of the liquid temperature</a> .
What to do?	As soon as the flow rate returns to within the permitted range, the warning is automatically reset.

### 20.10.4 Message "Temperature too low"

Message	Temperature too low
Symbol displayed	
Possible cause	The value of the liquid temperature is lower than the permitted minimum error value set in chpt. <a href="#">14.5.7 Changing the error limits, the warning limits and the hysteresis of the liquid temperature.</a>
What to do?	As soon as the value of the liquid temperature returns to within the permitted range, the error is automatically reset.

Message	Temperature too low
Symbol displayed	
Possible cause	The value of the liquid temperature is lower than the permitted minimum warning value set in chpt. <a href="#">14.5.7 Changing the error limits, the warning limits and the hysteresis of the liquid temperature.</a>
What to do?	As soon as the value of the liquid temperature returns to within the permitted range, the warning is automatically reset.

### 20.10.5 Message "Value totalizer 1 too high" or "Value totalizer 2 too high"

Message	Value totalizer 1 too high / Value totalizer 2 too high
Symbol displayed	
Possible cause	The value of the totalizer is higher than the permitted maximum error value set in chpt. <a href="#">14.7.5 Changing the error limits, the warning limits and the hysteresis of each totalizer</a>
What to do?	As soon as the value of the totalizer returns to within the permitted range, the error is automatically reset.

Message	Value totalizer 1 too high / Value totalizer 2 too high
Symbol displayed	
Possible cause	The value of the totalizer is higher than the permitted maximum warning value set in chpt. <a href="#">14.7.5 Changing the error limits, the warning limits and the hysteresis of each totalizer</a>
What to do?	As soon as the value of the totalizer returns to within the permitted range, the warning is automatically reset.





### 20.10.6 Message "Value totalizer 1 too low" or "Value totalizer 2 too low"

Message	Value totalizer 1 too low / Value totalizer 2 too low
Symbol displayed	
Possible cause	The value of the totalizer is lower than the permitted minimum error value set in chpt. <a href="#">14.7.5 Changing the error limits, the warning limits and the hysteresis of each totalizer</a>
What to do?	As soon as the value of the totalizer returns to within the permitted range, the error is automatically reset.

Message	Value totalizer 1 too low / Value totalizer 2 too low
Symbol displayed	
Possible cause	The value of the totalizer is lower than the permitted minimum warning value set in chpt. <a href="#">14.7.5 Changing the error limits, the warning limits and the hysteresis of each totalizer</a>
What to do?	As soon as the value of the totalizer returns to within the permitted range, the warning is automatically reset.

### 20.10.7 Message "Fluid velocity too high"

Message	Fluid velocity too high
Symbol displayed	
Possible cause	The value of the liquid velocity is higher than the permitted maximum error value set in chpt. <a href="#">14.6.7 Changing the error limits, the warning limits and the hysteresis of the liquid velocity.</a>
What to do?	As soon as the value of the liquid velocity returns to within the permitted range, the error is automatically reset.

Message	Fluid velocity too high
Symbol displayed	
Possible cause	The value of the liquid velocity is higher than the permitted maximum warning value set in chpt. <a href="#">14.6.7 Changing the error limits, the warning limits and the hysteresis of the liquid velocity.</a>
What to do?	As soon as the value of the liquid velocity returns to within the permitted range, the warning is automatically reset.

### 20.10.8 Message "Fluid velocity too low"

Message	Fluid velocity too low
Symbol displayed	
Possible cause	The value of the liquid velocity is lower than the permitted minimum error value set in <a href="#">chpt. 14.6.7 Changing the error limits, the warning limits and the hysteresis of the liquid velocity.</a>
What to do?	As soon as the value of the liquid velocity returns to within the permitted range, the error is automatically reset.

Message	Fluid velocity too low
Symbol displayed	
Possible cause	The value of the liquid velocity is lower than the permitted minimum warning value set in <a href="#">chpt. 14.6.7 Changing the error limits, the warning limits and the hysteresis of the liquid velocity.</a>
What to do?	As soon as the value of the liquid velocity returns to within the permitted range, the warning is automatically reset.

### 20.10.9 Message "Density factor too high"

Message	Density factor too high
Symbol displayed	
Possible cause	The value of the density factor is higher than the permitted maximum error value set in <a href="#">chpt. 14.8.8 Changing the error limits, the warning limits and the hysteresis of the density factor.</a>
What to do?	As soon as the value of the density factor returns to within the permitted range, the error is automatically reset.

Message	Density factor too high
Symbol displayed	
Possible cause	The value of the density factor is higher than the permitted maximum warning value set in <a href="#">chpt. 14.8.8 Changing the error limits, the warning limits and the hysteresis of the density factor.</a>
What to do?	As soon as the value of the density factor returns to within the permitted range, the warning is automatically reset.

### 20.10.10 Message "Density factor too low"

Message	Density factor too low
Symbol displayed	
Possible cause	The value of the density factor is lower than the permitted minimum error value set in <a href="#">chpt. 14.8.8 Changing the error limits, the warning limits and the hysteresis of the density factor.</a>
What to do?	As soon as the value of the density factor returns to within the permitted range, the error is automatically reset.

Message	Density factor too low
Symbol displayed	
Possible cause	The value of the density factor is lower than the permitted minimum warning value set in <a href="#">chpt. 14.8.8 Changing the error limits, the warning limits and the hysteresis of the density factor.</a>
What to do?	As soon as the value of the density factor returns to within the permitted range, the warning is automatically reset.

### 20.10.11 Message "Acoustic transmission factor too high"

Message	Acoustic transmission factor too high
Symbol displayed	
Possible cause	The value of the acoustic transmission factor is higher than the permitted maximum error value set in <a href="#">chpt. 14.9.6 Changing the error limits, the warning limits and the hysteresis of the acoustic transmission factor.</a>
What to do?	As soon as the value of the acoustic transmission factor returns to within the permitted range, the error is automatically reset.

Message	Acoustic transmission factor too high
Symbol displayed	
Possible cause	The value of the acoustic transmission factor is higher than the permitted maximum warning value set in <a href="#">chpt. 14.9.6 Changing the error limits, the warning limits and the hysteresis of the acoustic transmission factor.</a>
What to do?	As soon as the value of the acoustic transmission factor returns to within the permitted range, the warning is automatically reset.

## 20.10.12 Message "Acoustic transmission factor too low"

Message	Acoustic transmission factor too low
Symbol displayed	
Possible cause	The value of the acoustic transmission factor is lower than the permitted minimum error value set in chpt. <a href="#">14.9.6 Changing the error limits, the warning limits and the hysteresis of the acoustic transmission factor.</a>
What to do?	As soon as the value of the acoustic transmission factor returns to within the permitted range, the error is automatically reset.

Message	Acoustic transmission factor too low
Symbol displayed	
Possible cause	The value of the acoustic transmission factor is lower than the permitted minimum warning value set in chpt. <a href="#">14.9.6 Changing the error limits, the warning limits and the hysteresis of the acoustic transmission factor.</a>
What to do?	As soon as the value of the acoustic transmission factor returns to within the permitted range, the warning is automatically reset.

## 20.11 Messages due to diagnostics events

### 20.11.1 Message "Diagnostic is active"

Message	Diagnostic is active
Symbol displayed	
Possible cause	All the diagnostics are active on the device. See chpt. <a href="#">14.10 Diagnostics: monitoring special events in the process, on the sensor or on the electronics.</a>
What to do?	-

### 20.11.2 Message "Diagnostic is inactive"

Message	Diagnostic is inactive
Symbol displayed	-
Possible cause	All the diagnostics are inactive on the device. See chpt. <a href="#">14.10 Diagnostics: monitoring special events in the process, on the sensor or on the electronics.</a>
What to do?	-

### 20.11.3 Message "Not totally filled"

Message	Not totally filled
Symbol displayed	Depends on the device status the event is associated to.
Possible cause	<p>The tube is not totally filled. Thus not all the sensors are in contact with the liquid and measurement is not possible.</p> <p>The related event must be enabled. See <a href="#">chpt. 14.10 Diagnostics: monitoring special events in the process, on the sensor or on the electronics</a>.</p>
What to do?	→ Make sure the measurement tube is completely filled, for example by increasing the flow rate.

### 20.11.4 Message "Liquid out of range"

Message	Liquid out of range
Symbol displayed	Depends on the device status the event is associated to.
Possible cause	<p>The speed of sound in the liquid is out of range.</p> <p>The related event must be enabled. See <a href="#">chpt. 14.10 Diagnostics: monitoring special events in the process, on the sensor or on the electronics</a>.</p>
What to do?	→ Make sure the liquid in the pipe meets the technical specifications given in the data sheet for the device and in <a href="#">chpt. 6 Technical data</a> .

### 20.11.5 Message "Unstable flow rate"

Message	Unstable flow rate
Symbol displayed	Depends on the device status the event is associated to.
Possible cause	<p>The flow rate is not stable. The standard deviation of the flow rate measurements is too high.</p> <p>The related event must be enabled. See <a href="#">chpt. 14.10 Diagnostics: monitoring special events in the process, on the sensor or on the electronics</a>.</p>
What to do?	→ Make sure the operation of the equipment in the process, such as pumps and process valves, is correct.

### 20.11.6 Message "Low flow cut off"

Message	Low flow cut off
Symbol displayed	Depends on the device status the event is associated to.
Possible cause	The cut-off value of the flow rate has been used. The cut-off function must be enabled. See chpt. <a href="#">14.4.9 Enabling the cut-off function</a> . The related event must be enabled. See chpt. <a href="#">14.10 Diagnostics: monitoring special events in the process, on the sensor or on the electronics</a> .
What to do?	→ If necessary, increase the flow rate value until it is higher than the cut-off value.

### 20.11.7 Message "Change of liquid"

Message	Change of liquid
Symbol displayed	Depends on the device status the event is associated to.
Possible cause	A different liquid flows in the pipe. The message is active for 10 s on the display. The related event must be enabled. See chpt. <a href="#">14.10 Diagnostics: monitoring special events in the process, on the sensor or on the electronics</a> .
What to do?	→ Make sure the liquid flowing in the pipe is the correct one.

### 20.11.8 Message "Backward flow"

Message	Backward flow
Symbol displayed	Depends on the device status the event is associated to.
Possible cause	The liquid flows in the opposite direction as the one set in chpt. <a href="#">16.4 Setting the direction of the flow</a> . The related event must be enabled. See chpt. <a href="#">14.10 Diagnostics: monitoring special events in the process, on the sensor or on the electronics</a> .
What to do?	→ Make sure the liquid flows in the correct direction.

### 20.11.9 Message "Sound conductivity out of range"

Message	Sound conductivity out of range
Symbol displayed	Depends on the device status the event is associated to.
Possible cause	There are gas bubbles or solid particles in the liquid. The related event must be enabled. See <a href="#">chpt. 14.10 Diagnostics: monitoring special events in the process, on the sensor or on the electronics.</a>
What to do?	→ Search for malfunctions in the process. → Make sure the liquid has no gas bubbles and no solid particles.

### 20.11.10 Message "AO1 open loop" or "AO3 open loop"

Message	AO1 open loop or AO2 open loop
Symbol displayed	Depends on the device status the event is associated to.
Possible cause	There is a connection problem on the related output. The current measured in the current loop is too low compared to the expected output current. The related event must be enabled. See <a href="#">chpt. 14.10 Diagnostics: monitoring special events in the process, on the sensor or on the electronics.</a>
What to do?	→ Make sure the wiring of the related output is correct.

### 20.11.11 Message "AO1 Diag error" or "AO3 Diag error"

Message	AO1 Diag error or AO2 Diag error
Symbol displayed	Depends on the device status the event is associated to.
Possible cause	There is a connection problem on the related output or a high resistance is detected in the loop. The related event must be enabled. See <a href="#">chpt. 14.10 Diagnostics: monitoring special events in the process, on the sensor or on the electronics.</a>
What to do?	→ Make sure all the cables are correctly connected. → If the related analogue output is not used, disable it. See <a href="#">chpt. 17.4 Disabling an analogue output.</a>

## 20.11.12 Message "DO2 overload" or "DO3 overload"

Message	DO2 overload or DO3 overload
Symbol displayed	Depends on the device status the event is associated to.
Possible cause	An overload has been detected at the related digital output. A current higher than 700 mA has been detected at the related digital output.  The output has switched.  The related event must be enabled. See <a href="#">chpt. 14.10 Diagnostics: monitoring special events in the process, on the sensor or on the electronics.</a>
What to do?	→ Make sure all the cables are correctly connected.  → Make sure the current flowing through the related digital output is less than 700 mA.



## 21 SPARE PARTS AND ACCESSORIES



### CAUTION

Risk of injury and/or damage caused by the use of unsuitable parts.

Incorrect accessories and unsuitable replacement parts may cause injuries and damage the device and the surrounding area.

► Use only original accessories and original replacement parts from Bürkert.

Spare part or accessory		Order number
Unlocking magnetic key		690309
5-pin M12 female straight cable plug with plastic threaded locking ring, to be wired		917116
5-pin M12 female and 5-pin M12 male straight cable plugs, moulded at each end of a 1 m shielded cable		772 404
5-pin M12 female and 5-pin M12 male straight cable plugs, moulded at each end of a 3 m shielded cable		772 405
8-pin straight female M12 connector and strands with wire end ferrules, cable length 2 m		919061
büS adapter: 8-pin straight female M12 connector and 5-pin straight male M12 connector, cable length 0.5 m		773286
Female M12 connector with a 120 Ω termination resistor		772424
Y plug adapter for the male M12 connector		772420
büS cable, 50 m		772413
büS cable, 100 m		772414
USB-büS interface set		772426

## 22 PACKAGING, TRANSPORT



### CAUTION

Risk of injury due to a heavy device.

A heavy device can fall down during transport or during installation and cause injuries.

- ▶ Transport, install and dismantle a heavy device with the help of another person.
- ▶ Use appropriate tools.

### NOTICE

Damage due to transport

Transport may damage an insufficiently protected device.

- ▶ Transport the device in shock-resistant packaging and away from humidity and dirt.
- ▶ Do not expose the device to temperatures that may exceed the admissible storage temperature range.
- ▶ Protect the electrical interfaces using protective plugs.

## 23 STORAGE



### CAUTION

Risk of injury due to a heavy device.

A heavy device can fall down during transport or during installation and cause injuries.

- ▶ Transport, install and dismantle a heavy device with the help of another person.
- ▶ Use appropriate tools.

### NOTICE

Poor storage can damage the device.

- ▶ Store the device in a dry place away from dust.
- ▶ Storage temperature of the device: -20 – +70 °C.

## 24 DISPOSAL OF THE DEVICE

### NOTICE

Damage to the environment due to parts contaminated by the fluid.

- ▶ Dispose of the device and its packaging in an environmentally-friendly way.
- ▶ Comply with the regulations which concern the area of waste disposal.