

Overview



The SITRANS F M MAG 3100 P is designed to meet the most common specifications within chemical and process industries.

Benefits

- DN 15 to DN 300 (½" to 12")
- Included in Quick Ship Program (delivery time see PIA LCP)
- Most used flowmeter in the chemical and process industries with PTFE/PFA liner and Hastelloy electrodes
- Excellent chemical resistance
- Full scope of global approvals for hazardous areas:
 - ATEX, FM, CSA, IECEx
 - 24 V and 115/230 V Ex compact and remote
 - intrinsically safe ia analog output
- Comprehensive self-diagnostic for error indication and error logging
- Fully welded construction provides a ruggedness that suits the toughest applications and environments
- Easy commissioning, the SENSORPROM unit automatically updates settings.
- MAG 6000 I full NAMUR compliance
 - compliant with NE 21, NE 32, NE 43, NE 53 and NE 70

Application

The main applications of the SITRANS F M electromagnetic flow sensors can be found in the following fields:

- Chemical industry
- Process industry
- Pulp and paper
- Industrial waste water

Design

- Compact or remote mounting possible
- Easy "plug & play" field changeability of transmitter
- High temperature sensor for applications with temperatures up to 150 °C (302 °F)
- Meets EEC directives: PED, 97/23/EC pressure directive for EN1092-1 flanges, and CRN
- Build-in length according to ISO 13359
- Onsite or factory upgrade to IP68/NEMA 6P of a standard sensor.

Mode of operation

The flow measuring principle is based on Faraday's law of electromagnetic induction according to which the sensor converts the flow into an electrical voltage proportional to the velocity of the flow.

Integration

The complete flowmeter consists of a flow sensor and an associated transmitter MAG 5000, 6000 and 6000 I.

The flexible communication concept USM II simplifies integration and update to a variety of fieldbus systems such as HART, FOUNDATION Fieldbus H1, DeviceNet, PROFIBUS DP and PA, Modbus RTU/RS 485.

Pressure/temperature curve to EN (DIN) flanges, material A 105 carbon steel

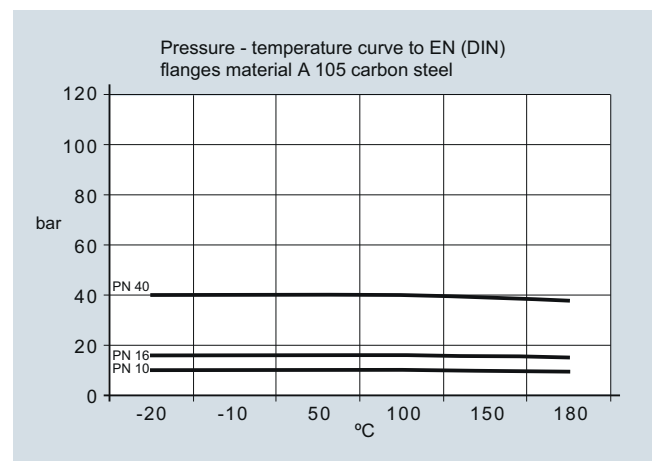

Pressure/temperature curve to ANSI B16.5 flanges

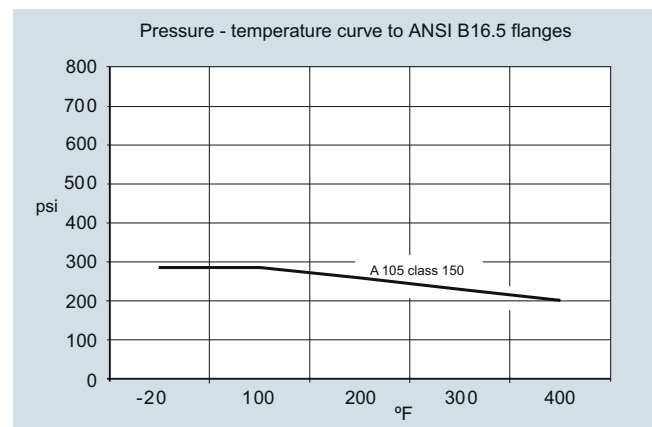

Note: The pressure-temperature curves only assist in the selection of a system. No responsibility is taken for the correctness of the information. For further information on the PED standard and requirements, see page 9/6.

Flow Measurement

SITRANS F M

Flow sensor MAG 3100 P

Technical specifications

Product characteristic	Chemical and process industry-oriented (Included in Quick Ship Program (delivery time see PIA LCP))	Design	
Nominal size	<ul style="list-style-type: none"> • PTFE: DN 15 ... 300 (½" ... 12") • PFA: DN 15 ... 150 (½" ... 6") 	Weight	See dimensional drawings
Measuring principle	Electromagnetic induction	Flange and housing material	Carbon steel ASTM A 105, with corrosion resistant two component epoxy coating (min. 150 µm)
Excitation frequency (Mains supply: 50 Hz/60 Hz)	<ul style="list-style-type: none"> • DN 15 ... 65 (½" ... 2½"): 12.5 Hz/15 Hz • DN 80 ... 150 (3" ... 6"): 6.25 Hz/7.5 Hz • DN 200 ... 300 (8" ... 12"): 3.125 Hz/3.75 Hz 	Measuring pipe material	AISI 304/1.4301
		Electrode material	PTFE: Hastelloy C276/2.4819 PFA: Hastelloy C22/2.4602
		Grounding electrode material	PTFE: Hastelloy PFA: Hastelloy
		Terminal box (remote version only)	<ul style="list-style-type: none"> • Standard fibre glass reinforced polyamide • Option Stainless steel AISI 316/1.4436 • Ex sensor: Stainless steel AISI 316/1.4436
Process connection		Cable entries	<ul style="list-style-type: none"> • Remote installation 2 x M20 or 2 x ½" NPT • Compact installation <ul style="list-style-type: none"> - MAG 5000/MAG 6000: 4 x M20 or 4 x ½" NPT - MAG 6000 I: 2 x M25 or 2 x ½" NPT (for supply/output) - MAG 6000 I Ex: 2 x M25 or 2 x ½" NPT (for supply/output)
Flanges	EN 1092-1, raised face ¹⁾ (EN 1092-1, DIN 2501 and BS 4504 have the same mating dimensions) <ul style="list-style-type: none"> • DN 15 ... 50 (½" ... 2"): PN 40 (580 psi) • DN 65 ... 300 (2½" ... 12"): PN 16 (232 psi) • DN 200 ... 300 (8" ... 12"): PN 10 (145 psi) ANSI B16.5 (~BS 1560), raised face <ul style="list-style-type: none"> • ½" ... 12": Class 150 (20 bar (290 psi)) 		
Rated operation conditions		Certificates and approvals	
Ambient temperature (conditions also dependent on liner characteristics)		Calibration	
<ul style="list-style-type: none"> • Standard sensor • Ex sensor • With compact transmitter <ul style="list-style-type: none"> - MAG 5000/6000²⁾ - MAG 6000 I - MAG 6000 I Ex 	-40 ... +100 °C (-40 ... +212 °F) -20 ... +60 °C (-4 ... +140 °F) -20 ... +60 °C (-4 ... +140 °F) -20 ... +60 °C (-4 ... +140 °F) -20 ... +60 °C (-4 ... +140 °F)	Standard production calibration, calibration report shipped with sensor	Zero-point, 2 x 25 % and 2 x 90 %
Operating pressure [abs. bar] (maximum operating pressure decreases with increasing operating temperature and with stainless steel flanges)	<ul style="list-style-type: none"> • PTFE Teflon <ul style="list-style-type: none"> - DN 15 ... 300 (½" ... 12") : 0.3 ... 40 bar (4 ... 580 psi) • PFA <ul style="list-style-type: none"> - DN 15 ... 150 (½" ... 6"): Vacuum 0.02 ... 50 bar (0.29 ... 725 psi) 	Conforms to	PED (All EN1092-1 flanges conforms to PED) – 97/23/EC ³⁾ CRN
Enclosure rating	IP67 to EN 60529/NEMA 4X/6, 1 mH ₂ O for 30 min Option: IP68 to EN 60529/NEMA 6P, 10 mH ₂ O cont. (not for Ex)	Material certificate EN 10204 3.1	Available when ordering together with meter ⁴⁾
Pressure drop at 3 m/s	As straight pipe	Ex approvals	Ex sensor <ul style="list-style-type: none"> • ATEX 2G D: DN 15 ... 300: EEx de ia IIC T3 - T6 • IEC Ex de ia IIC T3-T6 • FM Class I/II/III, Div 1 (compact only) • FM Class I, Zone 1/21 • CSA Class I, Zone 1/21 Standard sensor <ul style="list-style-type: none"> • FM Class I, Div 2 • CSA Class I, Div 2
Test pressure	1.5 x PN (where applicable)	Custody transfer (CT) (only together with MAG 5000/6000 CT), order as special	Other media than water - OIML R 117 (Denmark)
Mechanical load (vibration)	<ul style="list-style-type: none"> • 18 ... 1000 Hz random in x, y, z, directions for 2 hours according to EN 60068-2-36 • Sensor: 3.17 g RMS • Sensor with compact MAG 5000/6000 mounted transmitter: 3.17 g RMS • Sensor with compact MAG 6000 I/6000 I Ex mounted transmitter: 1.14 g RMS 		
Temperature of medium	<ul style="list-style-type: none"> • PTFE -20 ... +130 °C (-4 ... +266 °F) • PFA -20 ... +150 °C (-4 ... +302 °F) 		
EMC	2004/108/EC		

- 1) DN ≤ 600 type 01 (SORF); DN > 600 type 11 (WNRf)
- 2) With compact transmitter MAG 5000 CT/6000 CT -20 ... +50 °C (-4 ... +122 °F)
- 3) For further information on the PED standard and requirements, see page 9/6.
- 4) Has to be ordered with the meter. It is not possible to order the certificate afterwards.

Flow Measurement

SITRANS F M

Flow sensor MAG 3100 P

Selection and Ordering data

MAG 3100 P Type E grounding and protection ring

1 pc. **AISI 316** grounding and protection rings **type E** for PTFE liners incl. straps and screws

Type E

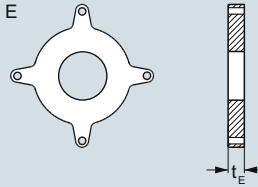

DN	PN 10 Article No.	PN 16 Article No.	PN 40 Article No.	ANSI ¹⁾	Class 150 Article No.
DN 15			FDK:083N8365	½"	FDK:083N8365
DN 25			FDK:083N8271	1"	FDK:083N8272
DN 40			FDK:083N8278	1½"	FDK:083N8279
DN 50			FDK:083N8282	2"	FDK:083N8283
DN 65		FDK:083N8285		2½"	FDK:083N8287
DN 80		FDK:083N8289		3"	FDK:083N8291
DN 100		FDK:083N8117		4"	FDK:083N8118
DN 125		FDK:083N8121		5"	FDK:083N8122
DN 150		FDK:083N8125		6"	FDK:083N8126
DN 200	FDK:083N8130	FDK:083N8130		8"	FDK:083N8370
DN 250	FDK:083N8136	FDK:083N8137		10"	FDK:083N8140
DN 300	FDK:083N8144	FDK:083N8145		12"	FDK:083N8148

Protection of PTFE liner use 2 pcs.

Earthing of PTFE lined flowmeter use 1 pc.

Selection and Ordering data

MAG 3100 P type E grounding and protecting ring

1 pc. **Hastelloy C276** grounding and protection ring **type E** for PTFE liners incl. straps and screws

Type E

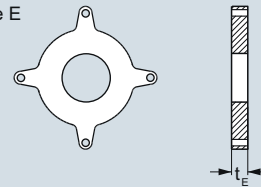

DN	PN 16 Article No.	PN 40 Article No.	Size	ANSI ¹⁾ Class 150 Article No.
DN 15		FDK:083N8487	½"	FDK:083N8487
DN 25		FDK:083N8488	1"	FDK:083N8489
DN 40		FDK:083N8490	1½"	FDK:083N8491
DN 50		FDK:083N8492	2"	FDK:083N8493
DN 65	FDK:083N8495		2½"	FDK:083N8497
DN 80	FDK:083N8499		3"	FDK:083N8501
DN 100	FDK:083N8504		4"	FDK:083N8506

¹⁾ For dimensions of MAG 3100 P see table on page 3/90

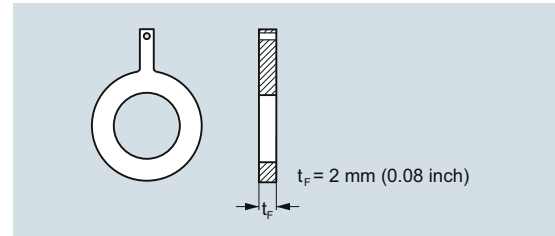
Selection and Ordering data**MAG 3100 P Grounding rings: Flat rings**1 pc. **AISI 316** grounding **flat ring** for all liners

DN	PN 10 Article No.	PN 16 Article No.	PN 40 Article No.	Size	ANSI ¹⁾ Class 150 Article No.
DN 15			A5E01191968	1/2"	A5E01191969
DN 25			A5E01150880	1"	A5E01150022
DN 40			A5E01191952	1 1/2"	A5E01191961
DN 50		A5E01191940	A5E01150918	2"	A5E01151121
DN 65		A5E01152876		2 1/2"	A5E01191962
DN 80				3"	A5E01152910
DN 100		A5E01158875		4"	A5E01159146
DN 125		A5E01191941		5"	A5E01191963
DN 150		A5E01191943		6"	A5E01191964
DN 200	A5E01191951	A5E01191944		8"	A5E01191965
DN 250	A5E01191950	A5E01191946		10"	A5E01191966
DN 300	A5E01191949	A5E01191947		12"	A5E01191967

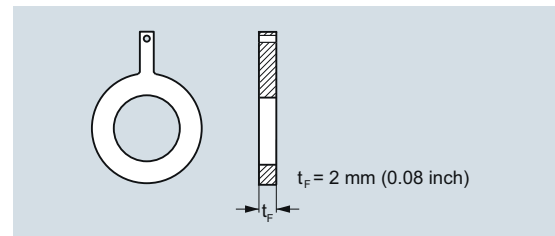
Selection and Ordering data**MAG 3100 P Grounding rings : Flat rings**1 pc. **Hastelloy C276** grounding **flat ring**

DN	PN 10 Article No.	PN 16 Article No.	PN 40 Article No.	Size	ANSI ¹⁾ Class 150 Article No.
DN 15			A5E01191981	1/2"	A5E01191989
DN 25			A5E01150882	1"	A5E01150028
DN 40			A5E01191982	1 1/2"	A5E01191990
DN 50		A5E01191971	A5E01150922	2"	A5E01151124
DN 65		A5E01152889		2 1/2"	A5E01191991
DN 80				3"	A5E01152913
DN 100		A5E01158886		4"	A5E01159150
DN 125		A5E01191973		5"	A5E01191992
DN 150		A5E01191974		6"	A5E01191993
DN 200	A5E01191978	A5E01191975		8"	A5E01191994
DN 250	A5E01191979	A5E01191976		10"	A5E01191995
DN 300	A5E01191980	A5E01191977		12"	A5E01191996

1) For dimensions of MAG 3100 P see table on page 3/90

Flow Measurement

SITRANS F M

Flow sensor MAG 3100 P

Dimensional drawings

MAG 3100 P sensor with compact or remote transmitter

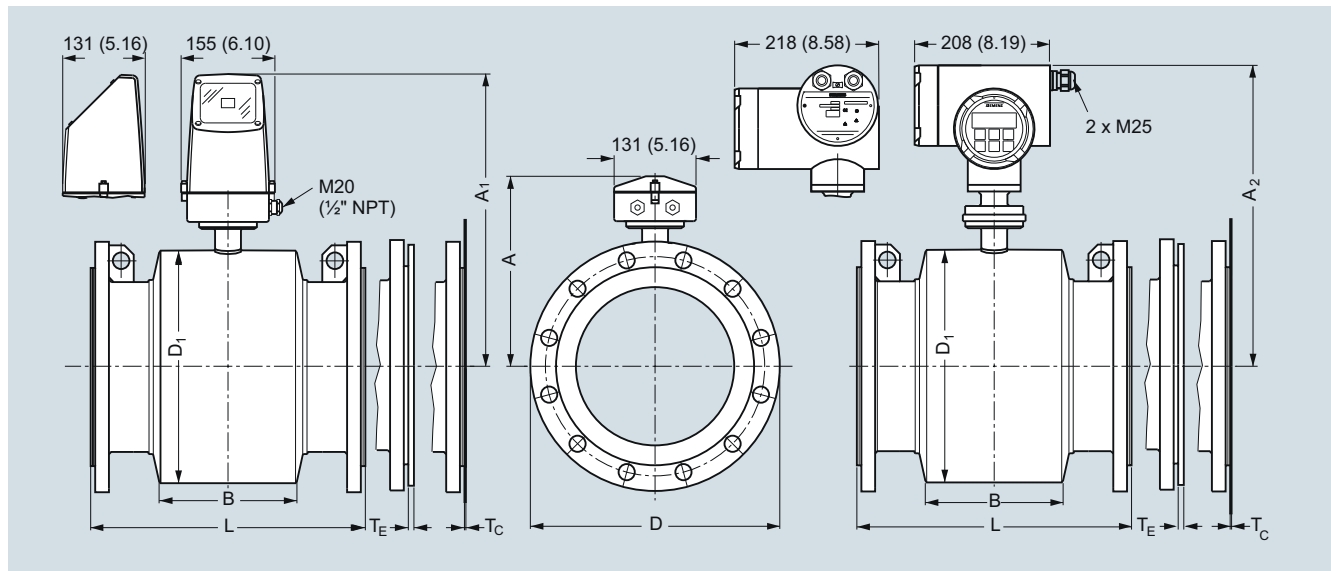

Dimensions in mm (inch)

Metric

DN	A ¹⁾	A ₁	A ₂	B	D ₁	L ²⁾			ANSI 16.5 Class 150	T _E ³⁾	T _F ³⁾	Wgt. ⁴⁾
						EN 1092-1-201 PN 10	PN 16	PN 40				
[mm]	[mm]	[mm]	[mm]	[mm]	[mm]	[mm]	[mm]	[mm]	[mm]	[mm]	[kg]	
15	187	341	338	59	104	-	-	200	200	6	2	4
25	187	341	338	59	104	-	-	200	200	6	2	5
40	197	351	348	82	124	-	-	200	200	6	2	8
50	205	359	356	72	139	-	-	200	200	6	2	9
65	212	369	366	72	154	-	200/-	-	200	6	2	11
80	222	376	373	72	174	-	200/-	-	272 ⁵⁾	6	2	12
100	242	396	393	85	214	-	250/-	-	250	6	2	16
125	255	409	406	85	239	-	250/-	-	250	6	2	19
150	276	430	427	85	282	-	300/-	-	300	6	2	27
200	304	458	455	137	338	350	350/-	-	350	8	2	40
250	332	486	483	157	393	450	450/-	-	450	8	2	60
300	357	511	508	157	444	500	500/-	-	500	8	2	80

1) 14.5 mm shorter with AISI terminal box (Ex and high temperature version)

2) When earthing flanges are used, the thickness of the earthing flange must be added to the built-in length

3) T_E = Type E grounding ring, T_F = Flat type grounding rings

4) Weights are approx. (for PN 16) without transmitter

5) Not according to ISO 13359

- not available

D = Outside diameter of flange, see flange tables

MAG 3100 P sensor with compact or remote transmitter

Imperial

Size	A ¹⁾	A ₁	A ₂	B	D ₁	L ²⁾				T _C ³⁾	T _E ³⁾	T _F ³⁾	Wgt. ⁴⁾
						EN 1092-1-201		ANSI 16.5					
[inch]	[inch]	[inch]	[inch]	[inch]	[inch]	PN 10	PN 16	PN 40	Class 150	[inch]	[inch]	[inch]	[lb]
½	7.36	13.4	13.34	2.32	4.09	-	-	7.87	7.87	-	0.24	0.08	9
1	7.36	13.4	13.34	2.32	4.09	-	-	7.87	7.87	0.05	0.24	0.08	11
1½	7.76	13.8	13.74	3.23	4.88	-	-	7.87	7.87	0.05	0.24	0.08	17
2	8.07	14.1	14.04	2.83	5.47	-	-	7.87	7.87	0.05	0.24	0.08	20
2½	8.35	14.4	14.34	2.83	6.06	-	7.87/-	-	7.87	0.05	0.24	0.08	24
3	8.74	14.8	14.74	2.83	6.85	-	7.87/-	-	10.71 ⁵⁾	0.05	0.24	0.08	26
4	9.53	15.6	15.54	3.35	8.43	-	9.84/-	-	9.84	0.05	0.24	0.08	35
5	10.04	16.1	16.04	3.35	9.41	-	9.84/-	-	9.84	0.05	0.24	0.08	42
6	10.87	16.9	16.84	3.35	11.10	-	11.81/-	-	11.81	0.05	0.24	0.08	60
8	11.97	18.0	17.94	5.39	13.31	13.78	13.78/-	-	13.78	0.05	0.31	0.08	88
10	13.07	19.1	19.04	6.18	15.47	17.72	17.72/-	-	17.72	0.05	0.31	0.08	132
12	14.05	20.1	20.04	6.18	17.48	19.69	19.69/-	-	19.69	0.06	0.31	0.08	176

1) 0.571 inch shorter with AISI terminal box (Ex and high temperature version)

2) When earthing flanges are used, the thickness of the earthing flange must be added to the built-in length

3) T_C = Type C grounding ring, T_E = Type E grounding ring, T_F = Flat type grounding rings

4) Weights are for ANSI 150 without transmitter

5) Not according to ISO 13359

- not available

D = Outside diameter of flange, see flange tables

FINE CONTROLS (UK) LTD

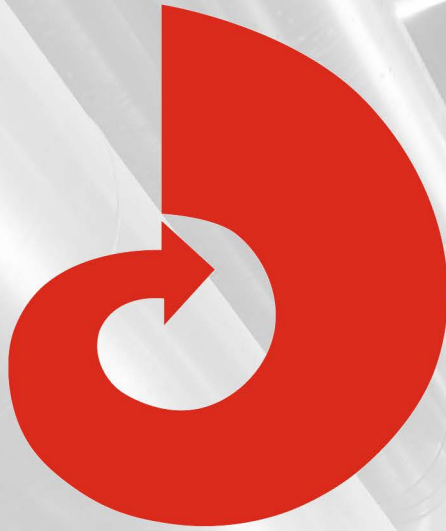

Fine Controls have been supplying process controls & instrumentation equipment since 1994, & now serves an ever expanding customer base, both in the UK & globally.

We offer a full range of valve & instrumentation products & services, with our product range representing leading technologies & brands:

Flow: Flow Meters & Transmitters, Flow Switches, Flow Control Valves & Batch Control Systems

Temperature: Temperature Probes & Thermowells, Temperature transmitters, Temperature Regulators & Temperature Displays

Level: Level Transmitters & Switches

Pressure: Pressure Gauges & Transmitters, Precision & High Pressure Regulators & I-P Converters, Volume boosters.

Precision Pneumatics: Pressure Regulators, I-P Converters, Volume Boosters, Vacuum Regulators

Valves: Solenoid & Pneumatic Valves, Control Valves & Positioners, Actuated Ball, Globe or Diaphragm Valves & Isolation Valves

Services: Repair, Calibration, Panel Build, System Design & Commissioning

 A rotork® Brand
FAIRCHILD



bürkert



SIEMENS



alcon
SOLENOID VALVES

A rotork® Brand



MIDLAND-ACS
A rotork® Brand



Honeywell



 **Bourdon**
Baumer Group



SOLDO
CONTROLS

A rotork® Brand



Fine Controls (UK) LTD, Bassendale Road, Croft Business Park,
Bromborough, Wirral, CH62 3QL UK
Tel: 0151 343 9966
Email: sales@finecontrols.com